



Operation manual

PROLINE Kryomats

Low-temperature thermostats
with SmartCool System

RP 4050 C, RP 4050 CW

RP 3090 C, RP 3090 CW

RP 4090 C, RP 4090 CW

Release 07/2022 k

Read the instructions before starting work!

°FAHRENHEIT. °CELSIUS. °LAUDA.

Manufacturer
LAUDA DR. R. WOBSE GMBH & CO. KG
Laudaplatz 1
97922 Lauda-Königshofen
Germany
Phone: +49 (0)9343 503-0
Fax: +49 (0)9343 503-222
E-Mail info@lauda.de
Internet <https://www.lauda.de>

Translation of the original operating instructions Q4DA-E_13-010-EN;
replaces release 03/2022 j, 08/2020 i, 11/2018 e, 10/2018 d, 05/2016 b2, 03/13, 01/09, 06/08

Valid from:

software control system (Master) version 2.13
software safety system (Master) version 2.07
software operating system (Command) version 3.45
software chilling system version 2.13
software analog IO module version 3.14
software serial IO module version 3.22
software digital IO module version 3.14
software solenoid valve version 3.06
software Ethernet module version 1.23
software EtherCAT module version 1.06

Prefixed safety notes



Before operating the equipment, please read carefully all the instructions and safety notes in Section 1.

If you have any questions, please phone us!

Follow the instructions on setting up, operation etc. This is the only way to avoid incorrect operation of the equipment and to ensure full warranty protection.

- The master head is supplied with power via the lower section of the unit. After switching off the head using the switch at the front of the head and/or using the switch at the back of the head, mains voltage is still present on the master head.
Switch off the unit by using the rotary switch on the front panel.
- Switch off the equipment and pull out the mains plug:
 - for servicing or repair,
 - moving the equipment!
- Transport the equipment with care!
The unit may NEVER be overturned nor put upside down!
- Equipment and its internal parts can be damaged:
 - by dropping,
 - by shock.
- Technically qualified personnel must only operate the equipment!
- Never operate the equipment without the heat transfer liquid!
- Do not start up the equipment if ...
 - it is damaged or leaking,
 - cable (not only supply cable) is damaged.
- Drain the bath before moving the equipment!
- Do not carry out any technical changes on the device!
- Have the equipment serviced or repaired by properly qualified personnel only!

The Operating Instructions include additional safety notes, which are identified by a triangle with an exclamation mark. Carefully read the instructions and follow them accurately! Disregarding the instructions may have serious consequences, such as damage to the equipment, damage to property or injury to personnel!

We reserve the right to make technical alterations!

Contents

	Prefixed safety notes.....	3
1	SAFETY INFORMATION	8
1.1	SAFETY INFORMATION.....	8
1.2	GENERAL SAFETY INFORMATION.....	9
1.3	OTHER SAFETY INFORMATION.....	10
1.4	OBLIGATIONS OF THE OPERATOR	11
1.5	FLUORINATED REFRIGERANT.....	11
2	BRIEF OPERATING INSTRUCTIONS	12
2.1	MENU STRUCTURE: MASTER.....	13
2.2	MENU STRUCTURE: COMMAND REMOTE CONTROL.....	14
3	CONTROLS AND FUNCTIONAL ELEMENTS	15
4	UNIT DESCRIPTION.....	19
4.1	ENVIRONMENTAL CONDITIONS.....	19
4.2	TYPES OF UNIT.....	19
4.3	VARIOFLEX PUMP	19
4.4	MATERIALS	20
4.5	TEMPERATURE DISPLAY, CONTROL AND SAFETY CIRCUIT.....	20
4.6	PROGRAMMER AND RAMP FUNCTION	21
4.7	INTERFACES	21
4.8	INTERFACE MODULES (ACCESSORIES).....	21
4.9	REFRIGERATING UNIT	22
4.10	AVOIDANCE OF DEWING	22
4.11	HEATER RATING AND POWER CONSUMPTION FROM THE MAINS.....	22
5	UNPACKING	23
5.1	AFTER UNPACKING.....	23
5.2	STANDARD ACCESSORIES.....	24
5.3	PACKING AND UNPACKING WITH ORIGINAL PACKAGING MATERIAL.....	24
5.3.1	<i>Background</i>	24
5.3.2	<i>Requirements</i>	24
5.3.3	<i>Unpacking the device</i>	25
5.3.3.1	Outer cardboard box	25
5.3.3.2	Lift device from the pallet	26
5.3.4	<i>Repacking with original packing material</i>	27
5.4	IN - PLANT TRANSPORT WITH HAND PELLET TRUCK OR FORK LIFTER.....	27
5.5	BEFORE PREPARATION	28
6	PREPARATION	29
6.1	ASSEMBLY AND SITING.....	29
6.2	FILLING AND DRAINING.....	30
6.3	CONNECTION OF THE COOLING WATER.....	32
6.4	HEAT TRANSFER LIQUIDS, COOLING WATER AND HOSES	33
6.5	CONNECTING EXTERNAL LOADS	36

7	STARTING UP	38
7.1	MAINS CONNECTION	40
7.2	SWITCHING ON	40
7.3	SWITCHING OFF / STANDBY	42
7.4	KEY FUNCTIONS.....	42
7.4.1	<i>General key functions and pilot lamps.....</i>	42
7.4.2	<i>Changing window information.....</i>	46
7.4.3	<i>Locking the keyboard.....</i>	47
7.5	IMPORTANT SETTINGS.....	49
7.5.1	<i>Temperature setpoint setting.....</i>	49
7.5.2	<i>Displaying the actual external temperature.....</i>	51
7.5.3	<i>Setting pump power or standby.....</i>	52
7.5.4	<i>Activate external pump.....</i>	54
7.5.5	<i>Activating external control.....</i>	54
7.5.6	<i>Current consumption from the mains.....</i>	56
7.5.7	<i>Setting the date and time.....</i>	57
7.5.8	<i>Display resolution setting.....</i>	58
7.6	SPECIAL SETTINGS.....	59
7.6.1	<i>Defining the type of start mode.....</i>	59
7.6.2	<i>Defining temperature limits.....</i>	60
7.6.3	<i>Setpoint offset operating mode.....</i>	61
7.6.4	<i>Restoring works settings.....</i>	62
7.6.5	<i>Setting the volume of the acoustic signals.....</i>	63
7.6.6	<i>Entering the offset of the internal temperature probe.....</i>	63
7.6.7	<i>Restoring the works setting of the internal temperature-probe offset.....</i>	64
7.6.8	<i>Entering the offset of the external temperature probe.....</i>	65
7.6.9	<i>Restoring the works setting of the external temperature-probe offset.....</i>	65
7.7	GRAPHICAL DISPLAY OF TEMPERATURE MEASUREMENTS.....	66
7.8	PROGRAMMER	68
7.8.1	<i>Program example.....</i>	68
7.8.2	<i>Selecting and starting the program (Start, Hold, Stop).....</i>	70
7.8.3	<i>Interrupting, continuing or terminating the program (Hold, Continue, Stop).....</i>	71
7.8.4	<i>Creating or modifying a program (Edit).....</i>	72
7.8.5	<i>Defining the number of program loops (Loops).....</i>	77
7.8.6	<i>Viewing the program sequence as a graph (Graph).....</i>	77
7.8.7	<i>Obtaining information on a program (Info).....</i>	78
7.9	RAMP FUNCTION.....	79
7.10	TIMER FUNCTION.....	80
7.11	CONTROL PARAMETERS.....	81
7.11.1	<i>Internal control variable (integral measurement probe).....</i>	82
7.11.1.1	<i>Proven settings for control parameters and pump (integral measurement probe).....</i>	82
7.11.2	<i>External control variable (External measurement probe).....</i>	82
7.11.2.1	<i>Steps for setting the control parameters for external control.....</i>	83
7.11.3	<i>Internal and external control parameter sets.....</i>	85
7.11.4	<i>Self Adaption.....</i>	86
7.12	ALARMS, WARNINGS AND ERRORS	89
7.12.1	<i>Overtemperature protection and checking.....</i>	89
7.12.2	<i>Low-level alarm and low-level checking.....</i>	91

7.12.3	<i>High-level settings</i>	92
7.12.4	<i>High-level warning or alarm</i>	93
7.12.5	<i>Pump-motor supervision: Overload or blockage</i>	94
7.12.6	<i>Pump-motor supervision: Dry running</i>	94
7.12.7	<i>Compressor Overtemp</i>	95
7.12.8	<i>Three-phase current</i>	95
7.12.9	<i>Fault list „Alarms and Warnings“</i>	96
8	INTERFACE MODULES	99
8.1	INSTALLING OF MODULES	99
8.2	MENU STRUCTURE FOR ALL MODULES.....	100
8.3	SERIAL INTERFACE RS 232/485.....	101
8.3.1	<i>Connecting cables and interface test RS 232</i>	101
8.3.2	<i>Protocol RS 232</i>	102
8.3.3	<i>Connecting cable RS 485</i>	102
8.3.4	<i>Protocol RS 485</i>	103
8.3.5	<i>Write commands (Data commands to the thermostat)</i>	103
8.3.6	<i>Read commands (Data requested from the thermostat)</i>	105
8.3.7	<i>Error messages</i>	107
8.3.8	<i>Driver software for LABVIEW®</i>	107
8.4	ANALOGUE MODULE.....	108
8.5	CONTACT MODULE	109
8.5.1	<i>Contact module LRZ 915 with three inputs and three outputs</i>	109
8.5.2	<i>Namur-Contact module LRZ 914 with only one input and one output</i>	110
9	MAINTENANCE	111
9.1	DEVICE STATUS	111
9.1.1	<i>Interrogating the device type</i>	111
9.1.2	<i>Software version</i>	111
9.1.3	<i>Serial numbers</i>	111
9.1.4	<i>Device data</i>	111
9.1.5	<i>Fault memory</i>	112
9.2	CLEANING.....	112
9.2.1	<i>Cleaning the surface of the device</i>	112
9.2.2	<i>Draining the water-cooled condenser</i>	113
9.3	SERVICING, CLEANING, REPAIR AND DISPOSAL INFORMATION.....	113
9.3.1	<i>Servicing</i>	114
9.3.2	<i>Service intervals</i>	115
9.3.3	<i>Testing the heat transfer liquid</i>	115
9.3.4	<i>Cleaning the condenser</i>	116
9.3.4.1	<i>Air-cooled condenser</i>	116
9.3.4.2	<i>Water-cooled condenser</i>	116
9.3.4.2.1	<i>Cleaning the dirt trap</i>	116
9.3.4.2.2	<i>Decalcifying the water cooling circuit</i>	117
9.3.5	<i>Repair information</i>	117
9.3.6	<i>Remedying faults</i>	118
9.4	DISPOSAL INFORMATION	119
9.4.1	<i>Disposal of the refrigerant</i>	119

9.4.2	<i>Disposal of the packaging</i>	120
9.5	HELP DESK AND ORDERING REPLACEMENT PARTS	120
10	ACCESSORIES	121
11	TECHNICAL DATA AND DIAGRAMS	122
11.1	INSTALLATION LOCATION.....	127
11.2	MAINS CONNECTION DATA	128
11.3	REFRIGERANT AND FILLING QUANTITY.....	128
12	DECLARATION OF CONFORMITY AND PRODUCT RETURNS DECLARATION	131
13	INDEX	133

1 Safety information

1.1 Safety information



Type and source
<i>Consequences of non-compliance</i>
<ul style="list-style-type: none">Action 1Action ...

"DANGER" indicates an immediate dangerous situation which – if the safety requirements are ignored – may result in fatal or severe, irreversible injuries.



Type and source
<i>Consequences of non-compliance</i>
<ul style="list-style-type: none">Action 1Action ...

"WARNING" indicates a possible dangerous situation which – if the safety requirements are ignored – may result in fatal or severe, irreversible injuries.



Type and source
<i>Consequences of non-compliance</i>
<ul style="list-style-type: none">Action 1Action ...

"CAUTION" indicates a possible dangerous situation which – if the safety requirements are ignored – may result in slight, reversible injuries.



Type and source
<i>Consequences of non-compliance</i>
<ul style="list-style-type: none">Action 1Action ...

"NOTICE" warns of possible property or environmental damage.



Reference

Refers to further information in other sections.



Note

Here special attention is drawn to some aspect.

1.2 General safety information

A heating and cooling thermostat heats or cools and circulates heat transfer liquids according to specified parameters. This involves hazards due to high or low temperatures, fire and general hazards due to the application of electrical energy.

The user is largely protected by the application of relevant standards.

Further hazard sources may arise due to the type of tempering medium, e.g. by exceeding or undercutting certain temperature thresholds or by the breakage of the container and reaction with the heat transfer liquid.

It is not possible to consider all eventualities. They remain largely subject to the judgment and responsibility of the operator.

The equipment must only be used as prescribed and as described in these operating instructions. This includes operation by instructed specialist personnel.

The equipment is not rated for use under medical conditions according to DIN EN 60601-1 or IEC 601-1.

Classification in accordance with EMC requirements of DIN EN 61326-1			
Device	Immunity requirements	Emissions class	Customer power supply
Proline Kryomat	Table 2 (Industrial) in accordance with DIN EN 61326-1	Emissions Class B in accordance with CISPR 11	Only for EU Domestic connection value ≥ 100 A
Proline Kryomat	Table 2 (Industrial) in accordance with DIN EN 61326-1	Emissions Class B in accordance with CISPR 11	Worldwide No limitation

Only for the USA:

Instructions for Class A digital devices

“This equipment has been tested and found to comply with the limits for Class A digital device, pursuant to Part 15 of the FCC (Federal Communication Commission) Rules. These limits are designed to provide reasonable protection against harmful interference when the equipment is operated in a commercial environment. This equipment generates, uses, and can radiate radio frequency energy and, if not installed and used in accordance with the instruction manual, may cause harmful interference to radio communications. Operation of this equipment in a residential area is likely to cause harmful interference in which case the user will be required to correct the interference at his own expense.”

“This device complies with Part 15 of the FCC (Federal Communication Commission) Rules. Operation is subject to the following two conditions: (1) This device may not cause harmful interference, and (2) this device must accept any interference received, including interference that may cause undesired operation.”

Only for Canada:

“This Class A digital apparatus complies with Canadian ICES-003” (ICES = Interference Causing Equipment Standards).

« Cet appareil numérique de la Classe A est conforme à la norme NMB-003 du Canada ».

1.3 Other safety information

- Only connect equipment to PE grounded mains sockets.
- At higher operating temperatures, parts of the bath cover can reach surface temperatures exceeding 70 °C. Be careful when touching it! → Danger of burning!
- Use suitable hoses (⇒ 6.3).
- Secure hose against slippage with the aid of hose clips. Avoid kinks in the hoses.
- Check hoses from time to time for any possible material fatigue.
- Thermal medium hoses and other hot parts must not come into contact with the mains cable.
- With the use of thermostats as circulating thermostats hot or cold liquid can be emitted when the hose breaks, presenting a hazard to persons and material.
- If no external load is connected, the pump outflow must be closed (use screw plugs) and the bypass valve must be set to "internal" (⇒ 4.3).
- Take into account the thermal expansion of the heat transfer oils with increasing bath temperature.
- Irritant vapors may develop, depending on the heat transfer liquid and operating mode used. Always ensure that the vapors are adequately extracted. Use the bath cover.
- By changing the heat transfer liquid from aqueous heat transfer liquid to a thermal transfer liquid for temperatures above 100 °C, carefully remove all water residues, including from the hoses and loads. **When doing this, also open the blanking caps of the pump outputs and inputs and blow compressed air through all the pump outputs and inputs.** → Danger of scald due to delay in boiling!
- Withdraw the mains plug before cleaning, maintenance or moving the thermostat.
- Specialist personnel must only carry out repairs in the control section.
- Figures of temperature constancy and display accuracy apply under normal conditions according to DIN 12876. Electromagnetic high frequency fields may in special cases lead to unfavorable values. Safety is not impaired.
- The following action may start the thermostat unintentionally from the standby mode: Previously activated timer mode (⇒ 7.10), "Start" command via interfaces (⇒ 8).

Only water-cooled devices:

- The return hose of the water-cooling must be securely fixed on the outlet port in order to prevent the hose sliding off uncontrollably, also during pressure surges.
- The return hose of the water-cooling must be fixed on the outlet port that hot cooling water cannot splash out.
- It is essential to prevent kinking or squashing of the return hose for the water cooling. Excessive pressure can cause the cooling water hoses to tear and hot water to escape.
- To prevent damages by a leakage of the cooling water system its recommended to use a leak-water detector with shut-off valve (Aqua Stop).

1.4 Obligations of the operator

The national regulations for operation applicable in the country in which the system is installed must be complied with.

In particular, the application of statutory regulations concerning operational safety must be observed.

Note the installation conditions outlined in Chapter (11.1 Installation location).

Operators within the EU must meet the applicable provisions of Regulation (EU) No. 517/2014 on fluorinated greenhouse gases. The regulation provides a complete overview, and includes:

- The general purpose of the regulation is to reduce emissions of fluorinated greenhouse gases.
- Regular tightness checks, depending on the quantity of CO₂ equivalent (see type plate and regulation; regular tightness checks may be necessary if the CO₂ equivalent exceeds 5 t).
- Having leakage inspections, maintenance, repairs, decommissioning or recovery work carried out by certified, authorized personnel (for example LAUDA Service).
- Keeping records of refrigerants added or recovered, including quantity and type. Records must be kept for a minimum of 5 years.

1.5 Fluorinated refrigerant

Refrigeration process thermostats are operated with fluorinated refrigerants.

The designation and refrigerant charge are specified on the type plate.

2 Brief operating instructions



These brief instructions shall give you the possibility to operate the unit quickly. For safe operation of the unit, it is necessary to read carefully all the instructions and safety notes!

1. Assemble unit and add items as appropriate (⇒ 6.1).
The unit may NEVER be overturned nor put upside down!
Take care of the hose tubing connections (⇒ 6.3 and 0).
2. Fill the unit with corresponding heat transfer liquid (⇒ 6.3). The units are designed for operation with non-flammable and flammable liquids to DIN EN 61010-2-010. → Take care of the level of the heat transfer liquid! (⇒ 6.2).
3. Compare the information on the rating label with the supply details.
4. Connect the unit only to a socket with a protective earth (PE) connection.



5. Check whether the switch at the back of the master control element is in the "ON = -" position.



6. Check whether the switch at the front of the master control element is in the "ON = |" position.

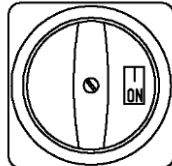

7. Set the rotary switch on the front panel to "ON = |". The unit starts operating.

8. With  set the overtemperature cut-off point to a value clearly above room temperature (⇒ 7.12.1).

9. Now you see the current bath temperature in the display, for example:

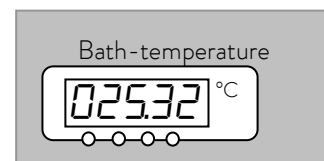

If instead, a warning or error message is displayed, then refer to Section 7.12.

2.1 Menu structure: Master

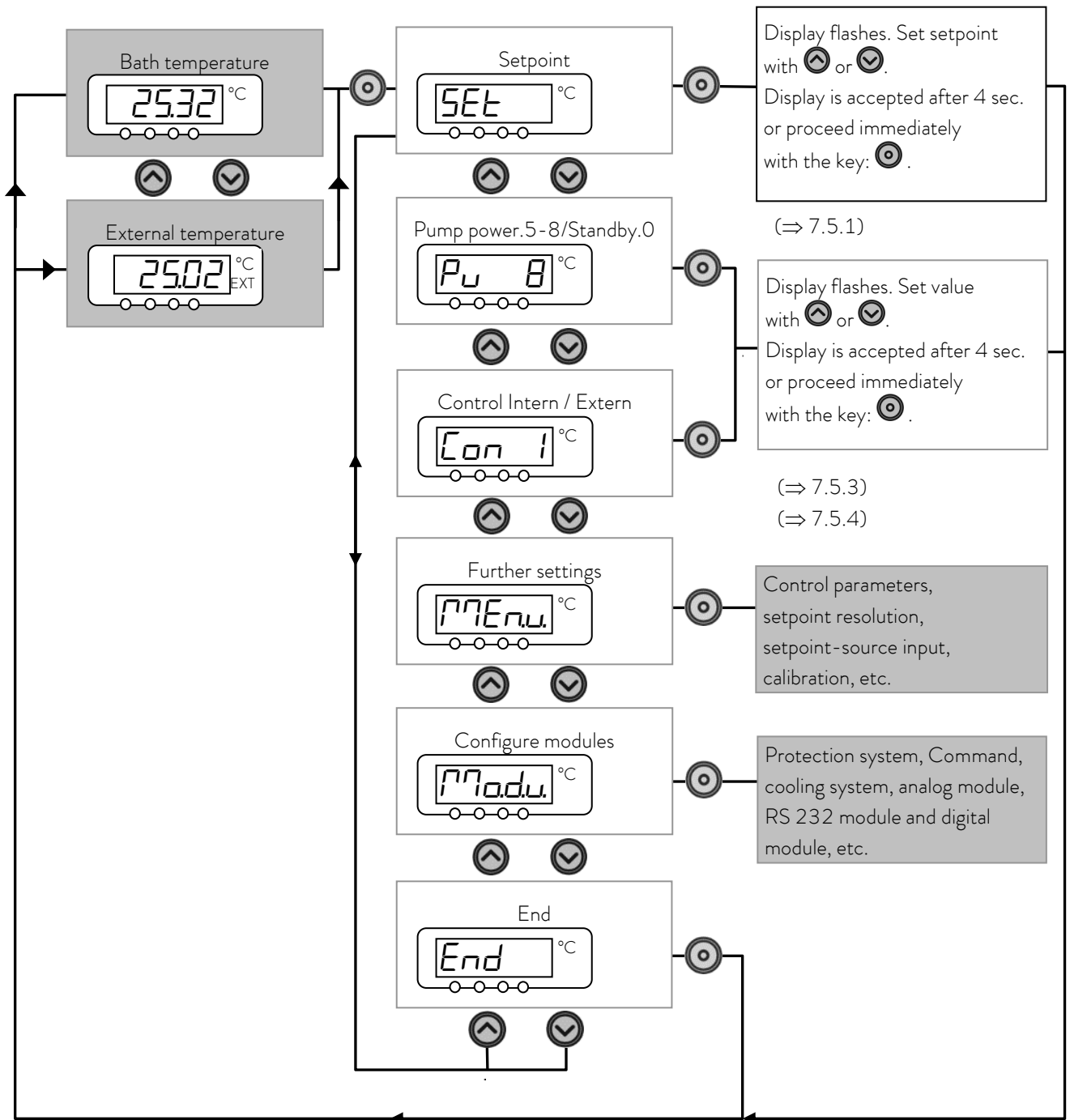

These settings and configurations can be entered more easily and in a more clear manner via the Command remote control. Therefore, for the Master control element they are not explained in more detail in this operating manual.

3 Controls and functional elements

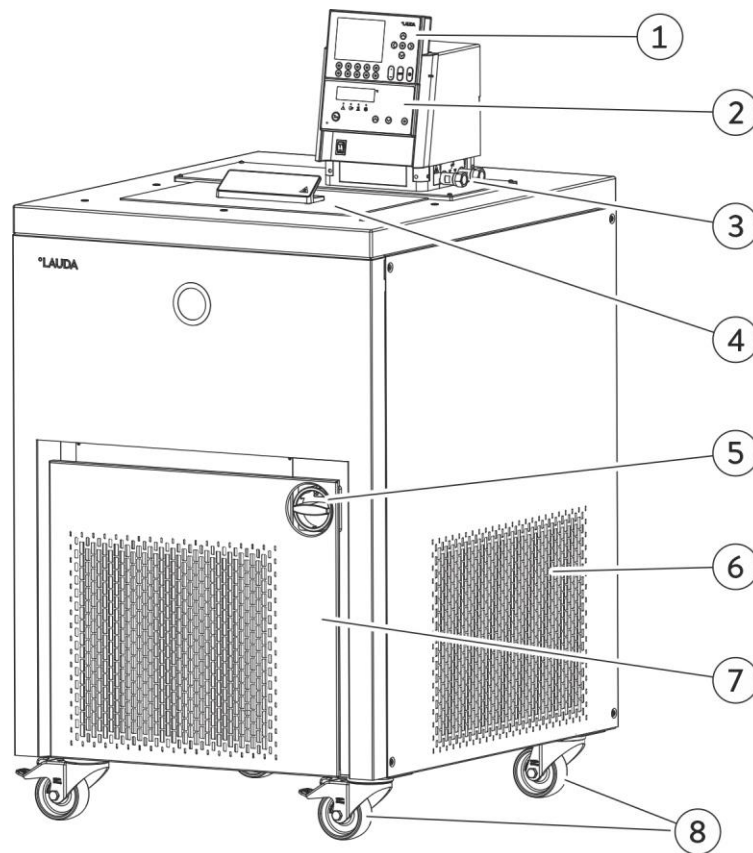

- | | | | |
|---|---|---|---|
| 1 | Command remote control (see page 15) | 5 | Rotary switch for power supply |
| 2 | Master control element | 6 | Grille (on both sides) |
| 3 | Pump connection on the side and Bypass valve (see illustration on this page). | 7 | Front cover (closed) |
| 4 | Bath cover | 8 | Four steering transport rollers, two off them with stoppers |

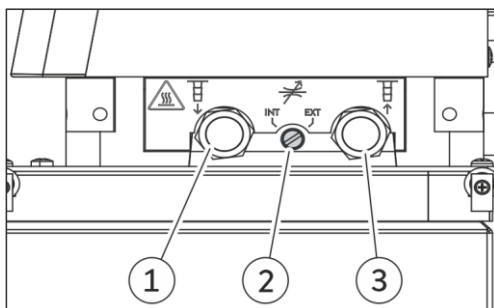

- | | |
|---|---|
| 1 | Pump connection on the side:
Pump outflow (pressure output)
closed off with screw |
| 2 | Bypass valve (in "external" position) |
| 3 | Pump connection on the side:
Suction nozzle (return to bath)
closed off with screw plug |

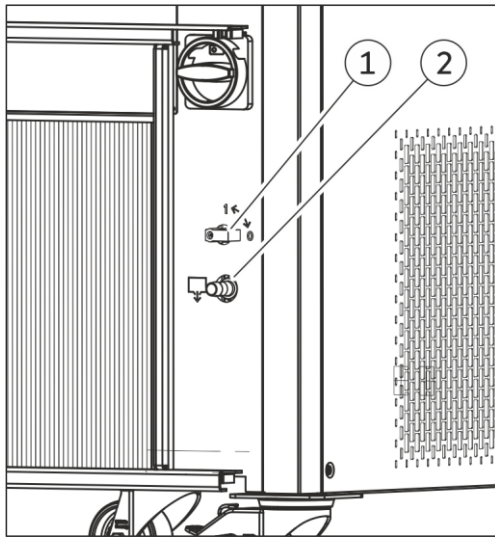

With the front panel open, access to the drain cock:

- 1 Bath drain tap
- 2 Bath drain nozzle

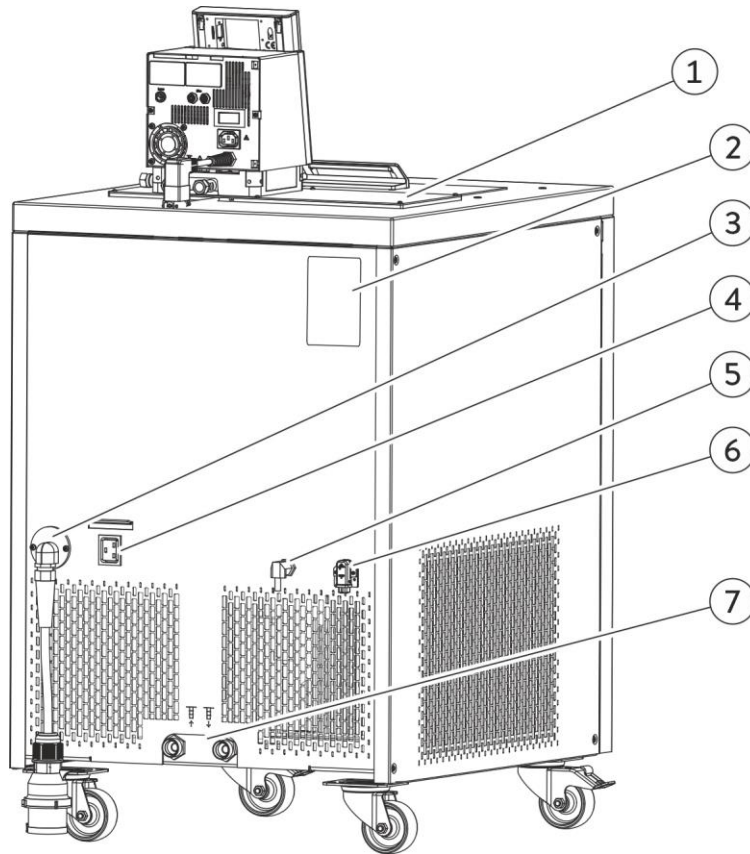

- 1 Bath edge heating and bath bridge heating
- 2 Nameplate
- 3 Mains cable
- 4 Connection cable for control head
- 5 Connection cable LiBus for control head
- 6 Connection bath bridge heating
- 7 Cooling water connections (at water-cooled devices W only), connections as per pictogram

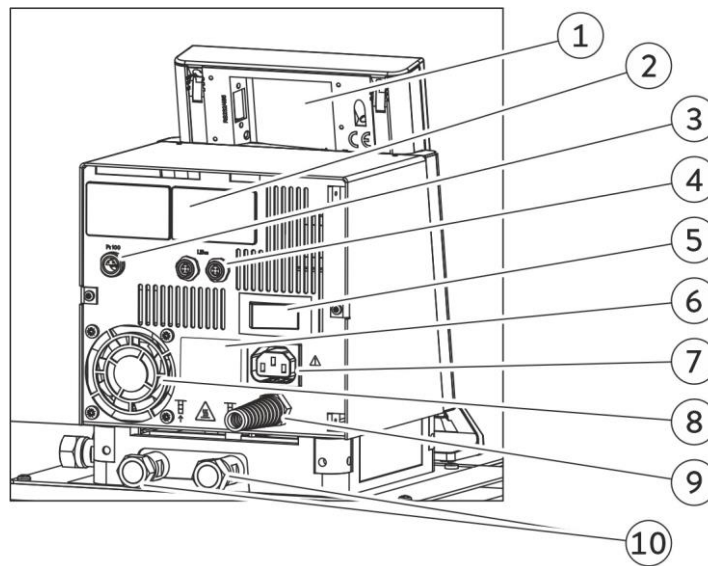

- | | | | |
|---|--|----|---|
| 1 | Command remote control (see next page) | 6 | Connection socket 51H |
| 2 | Covers for the two module slots | 7 | Air intake for electronic head |
| 3 | Connection socket 10S
for the external Pt100 temperature probe | 8 | Pump connection rear and on the side:
Suction nozzle (return to bath) & pump outflow or
pressure output
refer to housing for label |
| 4 | Connection socket LiBus (LAUDA internal bus) for bus
suitable for unit and to which the refrigerating lower section
and Command remote control are connected | 9 | Mains connecting lead |
| 5 | Mains switch | 10 | Rear pump connections |

Control element: Master

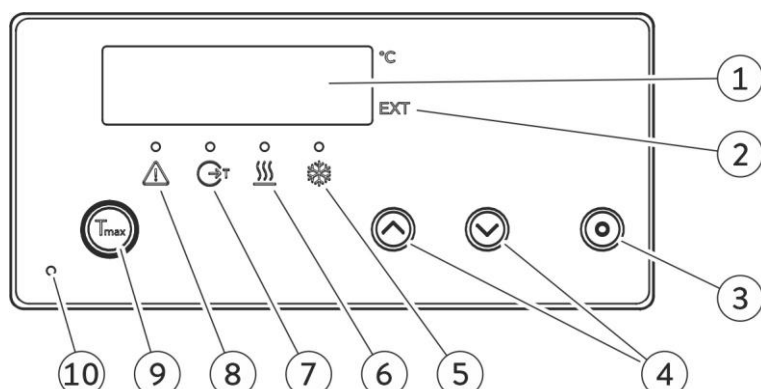

- | | | | |
|---|--|----|---|
| 1 | Display | 6 | Heater active (yellow LED is lit) |
| 2 | The temperature of an external source is displayed (EXT is lit green). | 7 | Bath controlled by external temperature source (green LED is lit) |
| 3 | Enter key | 8 | Error signal (red LED is blinking) |
| 4 | Select keys | 9 | Overtemperature set point to check or set Tmax |
| 5 | Cooler active (blue LED is lit) | 10 | Mains On (green LED is lit) |

Control element: Command

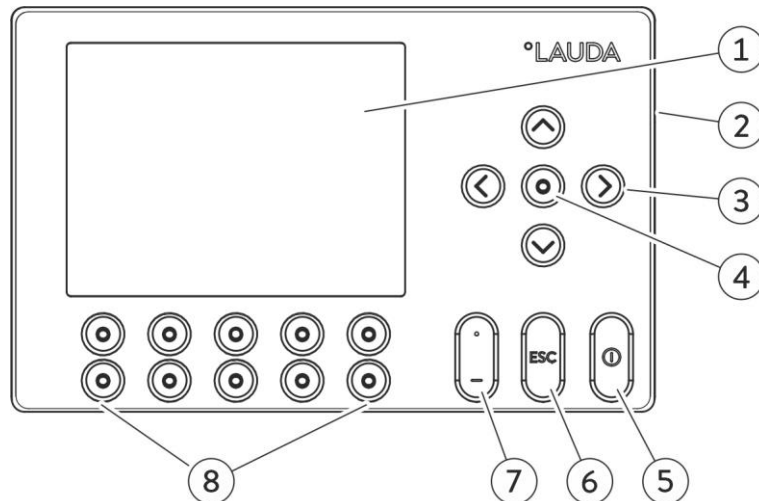

- | | | | |
|---|---|---|---|
| 1 | Graphical display | 5 | Standby key; brings the thermostat into the idle mode (Heater, refrigerating machine and pump are switched off, yellow LED is lit). |
| 2 | RS 232/485-socket (hidden on the back of Command) | 6 | Escape key to quit a window without any changes |
| 3 | Cursor keys | 7 | Decimal point or "-" symbol |
| 4 | Enter key | 8 | Five soft-key duo-keys – their associated functions are shown in the display. |

4 Unit description

4.1 Environmental conditions

The operation of the thermostats is only allowed under the following conditions as specified in DIN EN 61010-2-010:2003 and DIN EN 61010-1:2001:

- Indoor use only.
- Altitude up to 2000 m above sea level.
- Foundation must be dense, even, non-slippery and non-flammable.
- Keep clear distance (⇒ 6.1 Assembly and siting).
- Ambient temperatures range (⇒ 11 Technical data).
Use only within this range for an undisturbed operation.
- Mains supply voltage fluctuations (⇒ 11 Technical data).
- Relative humidity (⇒ 11 Technical data).
- Transient over voltage according to Installation Categories (Over voltage Categories) II.
- Pollution degree: 2.

4.2 Types of unit

The type designation of the Proline Kryomats comprises the prefix R (to designate the refrigeration machine), a P for Proline, the bath volume in liters and the lowest bath temperature (guide figure without arithmetic sign). The designation is supplemented with a "C" which indicates the presence of the Command remote control. For units with water-cooling, the type designation is supplemented with a "W".

Examples: RP 4090 CW is a low-temperature thermostat with 40-liter bath and -90 °C lowest temperature. The unit has a Command remote control and is water-cooled.

4.3 Varioflex pump

All units are fitted with a Varioflex pump with a 4-stage variable drive (pump level 5 to 8). The pump power can therefore be optimally matched to the relevant task. In order to achieve optimum temperature homogeneity in the heat transfer liquid in the bath, it is recommended to select the pump level in dependence of the viscosity of the heat transfer liquid; therefore at higher viscosity to increase the pump level.

Be cautious at higher bath levels to avoid liquid to slop over the bath edge.

The user cannot set the pump levels 1 to 4, because there is no sufficient temperature homogeneity in the bath vessel. With pump level 0 the unit goes into the standby mode. It should be noted that the heat input of the pump into the bath increases with increasing pump level.

With the Varioflex pump, open containers can be operated at a constant level when a level controller (accessory LCZ 0660) is used.

At the right-hand side and at the back of the unit outflow and inflow nozzles of the pump are fitted for external loads. This means that up to two external loads can be directly connected without a distributor. Pump connections, which are not required, must be closed off with the supplied caps and union nuts.

A bypass valve can subdivide the total volume flow variably between the bath (internally) and the connected load (externally). Attention: the external application must not block the volume flow. If no load is connected to the pump connector, the bypass valve must be set to the "internal" position for the best bath circulation. All pump connections must be closed off with the supplied caps and union nuts.

The pump connections on the unit are fitted with M16 x 1 thread.

The Varioflex pump operates short-term up to viscosity of 150 mm²/s. In the closed-loop control mode 50 mm²/s should not be exceeded. The temperature control is the best with 30 mm²/s and lower viscosity.

For operation as a circulating thermostat with an external load, the highest possible power level is practicable to maintain the temperature difference low, among other things also with higher temperatures in conjunction with oils as heat transfer liquid.

Pump characteristics (⇒ 11).

4.4 Materials

All parts being exposed to the heat transfer liquid are made of high quality material appropriate to the operating temperature. Non-rusting stainless steel and high quality temperature-resistant, primarily solvent-resistant plastics are used.

4.5 Temperature display, control and safety circuit

The Master control element is equipped with a 5-character green LED display, which is used for the display of the measurements and settings, as well as the operating status. The entry of setpoints and other settings occurs under menu guidance via four keys.

The more comfortable and removable Command remote control includes a backlit graphical display. The entry of the setpoint and other settings occurs under menu guidance via situation-dependent cursor keys and soft keys.

A Pt100 temperature probe acquires the current temperature in the bath. A high-resolution A/D converter processes the measurement. Further measurement conditioning occurs using a special control algorithm for controlling the heater actuator, which has a low reactive effect on the mains, and the SmartCool refrigeration equipment together with further transducers.

An external Pt100 temperature probe can be connected via a socket (10S) for the acquisition of an external temperature. This value can be displayed and, if required, used as the controlled variable with external control (Master) switched on. In this way, the system controls the external measurement and not the internal bath temperature (⇒ 7.5.4).

The safety system conforms to DIN EN 61010-2-010. The SelfCheck Assistant monitors about 50 unit parameters. A dual-channel system is used in which two microcontrollers monitor one another. Along with the bath temperature measurement and control probes, there are also two safety temperature probes (Pt100) for the safety circuit for the overtemperature cut-off and for monitoring the bath temperature probe.

The overtemperature cut-off point is displayed on pressing the key  on the Master.

Changing the overtemperature cut-off point: (⇒ 7.2 Switching on) on page 40.

The bath level is acquired by the SelfCheck Assistant in 8 stages. If the minimum level is undercut, the pump, heater and the SmartCool System refrigerating machine are switched off. The reaction of the thermostat in case of overfill can be set to simply display a warning, to display a warning and switch off the heater or to switch off the unit completely with pump, heater and SmartCool System refrigerating machine.

When the level is too low, with overtemperature, or with other alarms the SelfCheck Assistant switches the heater off on all poles. The pump and the refrigerating machine are also switched off.

This switch-off under fault conditions is retained, i.e. after the fault is rectified, the fault must be reset (released) on the Master operating panel with the  key.

Other unit functions are described in the appropriate sections and in Section 7. (Starting up).

4.6 Programmer and ramp function

Master control element:

No programmer provided.

Command remote control:

The units are equipped with a programmer function, which enables five temperature/ time programs to be saved. Each program consists of a number of temperature/ time segments. These also include details of how often the program is to be executed. Up to 150 segments can be distributed amongst the five programs.

With the ramp function, a rate of change can be directly entered in K/ unit time (⇒ 7.8).

4.7 Interfaces

The device is equipped in series with the following sockets:

- One socket (10S) for the connection of an external Pt100 temperature probe.
- Two sockets (70S) for the connection of components via the LAUDA equipment bus (cooling section, Command remote control, external solenoid valve, etc.).
- An RS 232/485 interface (65S) at the back of the Command remote control.

4.8 Interface modules (accessories)

The Master control element can be supplemented with further interface modules, which are simply inserted into two module slots (⇒ 3) at the back of the control head.

The following modules are currently available:

1. **RS 232/485 Interface Module** (Order No. LRZ 913) with 9-pole SUB-D socket. Electrically isolated through optocouplers. Command set largely compatible with the Ecoline, Integral XT and Integral T Series. The RS 232 interface can be directly connected to the PC with a cable wired 1:1 straight through (Order No. EKS 037).
Further details can be found in section 8.3.
2. **Analog Module** (Order No. LRZ 912) with two inputs and two outputs on 6-pole DIN socket. The inputs and outputs can be set independently as 4 – 20 mA, 0 – 20 mA or 0 – 10 V interface.
Further details can be found in section 8.4.

3. **Contact Module** (Order No. LRZ 915) on 15-pole SUB-D socket. With three relay contact outputs (changeover, max. 30 V / 0.2 A) and three binary inputs for control via external voltage-free contacts. Plug 15-pole (Order No. EQM 030) and plug case (Order No. EQG 017).
Further details can be found in section 8.5.
4. **Contact Module** (Order No. LRZ 914) with connector to NAMUR NE28. Functionality as LRZ 915, but only one output and only one input on each of two DIN sockets. Coupling socket 3-pole (Order No. EQD 047) and coupling plug 3-pole (Order No. EQS 048).
Further details can be found in section 8.5.
5. **Profibus Modules** (Order No. LRZ 917).
Further details can be found in the operating instructions of the Profibus Modules (Order No. Q4DA-E_13-014).

4.9 Refrigerating unit

The refrigerating machine mainly consists of one or two fully hermetically sealed compressors. The heat from the condensation process and the motor is dissipated via a lamellar condenser. Here, fresh air is drawn in at the front of the unit, heated in the unit and output at the back and the side. To ensure proper air circulation the ventilation slots must not be restricted respectively covered (⇒ 6.1).

The Proline Kryomats are equipped with the SmartCool technology, which makes optimum use of the compressor and only then cools when refrigerating capacity is demanded by the controller. To achieve this, a number of sensors in the cooling circuit monitor the operating conditions.

The compressors are equipped with overtemperature cutouts, which respond to the compressor temperature and the compressor current consumption. In addition, the refrigeration system is backed up by a pressure control device against over pressure. The cooling unit is normally switched in automatically, but can be switched manually via the operating menu with Command remote control (⇒ 2.2) and with Master control element (⇒ 2.1).

When the fault circuit trips, the refrigerating unit is also switched off.

Cooling curves (⇒ 11).

4.10 Avoidance of dewing

In order to avoid dewing on the edge of the bath when using the low temperatures of the thermostats, the devices are equipped with a bath bridge heating and a bath edge heating, using the waste heat of the refrigerating unit.

4.11 Heater rating and power consumption from the mains

The Proline Kryomats has an extraordinarily high heater rating of 3.5 kW maximum. While the compressor is running the power consumption and therefore the heater power is reduced.

5 Unpacking



Shipping damage
<i>Electric shock hazard</i>
<ul style="list-style-type: none"> • Check the device carefully for shipping damage before putting into operation. • Never operate the device if you have found shipping damage.



Falling down / falling over of the device
<i>Crushing of hands and feet, impacts</i>
<ul style="list-style-type: none"> • Use a suitable lifting tool. • Site the device only on a level surface. • Observe the packing instructions.

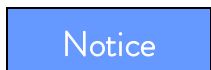

Falling / toppling equipment
<i>Property damage</i>
<ul style="list-style-type: none"> • Do not tilt the cooling device during transport and never turn it upside down.

To repack the unit carefully and properly, it is necessary to store the original package!

5.1 After unpacking

After unpacking, first check the device and accessories for any damage in transit. If, contrary to expectations, there is visible damage to the unit, the shipper must be immediately informed, so that an investigation can be made. Please also inform the LAUDA Service (Contact ⇨ 9.3.6).

5.2 Standard Accessories

Article number	Quantity	Article	Device
Q4DA-E_13-010-EN	1	Operating instructions	for all Kryomats
LRT 927	1	Command remote control	for all Kryomats
HDQ 173	1	Bath cover with grip	for RP 4050 C, RP 4050 CW, RP 4090 C and RP 4090 CW
HDQ 174	1	Bath cover with grip	for RP 3090 C and RP 3090 CW
HKO 026 (UD 413)	2	Hose olive Ø 13 mm	for all Kryomats
HKM 032	4	Union nuts for olives (M16 x 1)	already mounted, for all Kryomats
HKN 065	4	Screw plugs (for M16 x 1)	already mounted, for all Kryomats
EOA 001	2	Threaded hose coupling Nipple ½“; Nut G ¾“	for water-cooled devices only
EZB 260	1	Warning label "Hot surface" 	for all Kryomats

5.3 Packing and unpacking with original packaging material

5.3.1 Background

For the customer to allow a properly packaging, e.g. for further transport or return transport to LAUDA.



- To repack the unit carefully and properly, it is necessary to store the original package!
- The pictures may show devices with other ventilation openings, this has no influence on the unpacking and packing.

5.3.2 Requirements

You need a crane with two textiles round slings or lashings; or a fork lifter with adjustable fork.

5.3.3 Unpacking the device

5.3.3.1 Outer cardboard box



Open the cardboard box on top.

Pallet

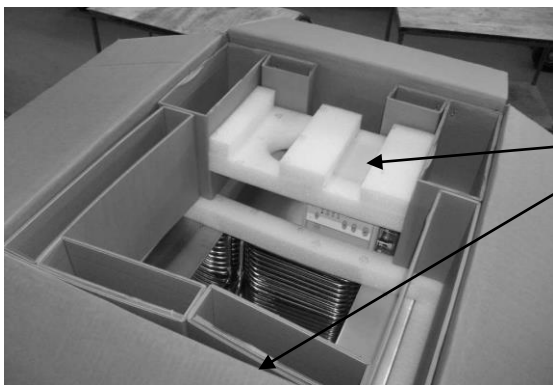

Take out the filling material and the accessory parts.

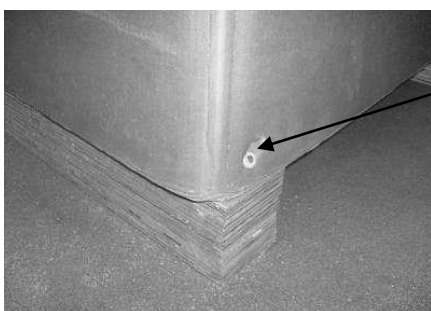

Draw out the four nails on the edge, which fix the cardboard box on the pallet.

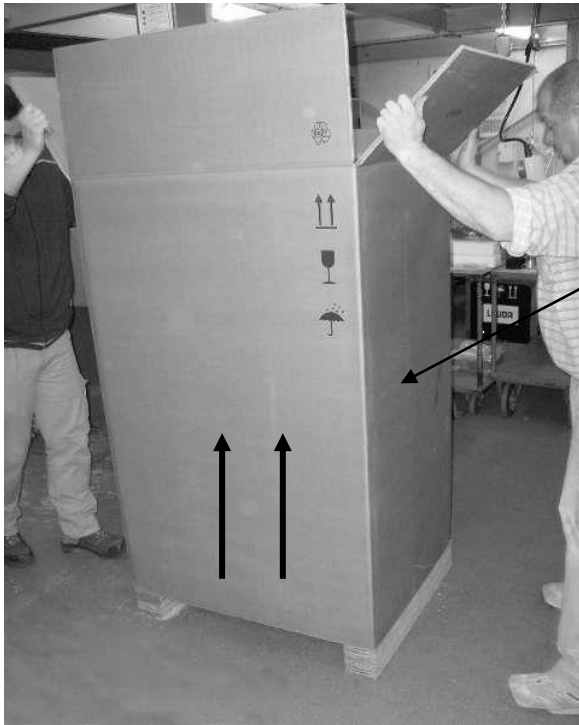

Remove the outer cardboard box vertically upwards.

5.3.3.2 Lift device from the pallet

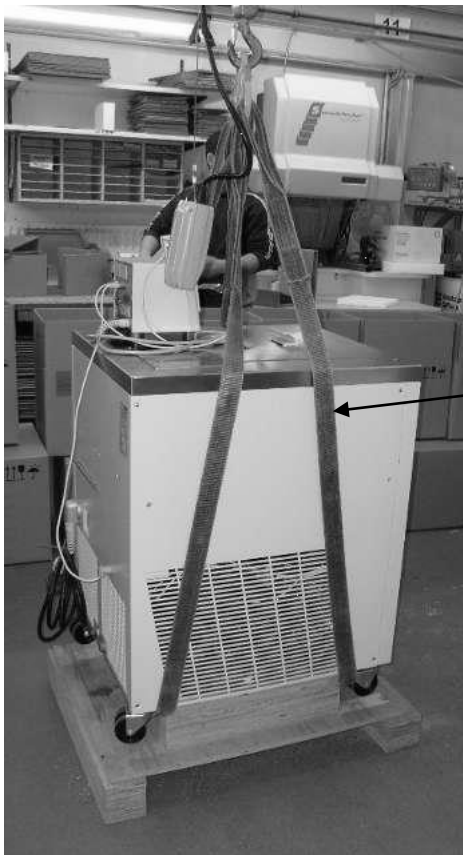

Two textile round slings

Attention:

The round slings must not press against the structure of the device!



– Pay attention to the center of gravity of the device!

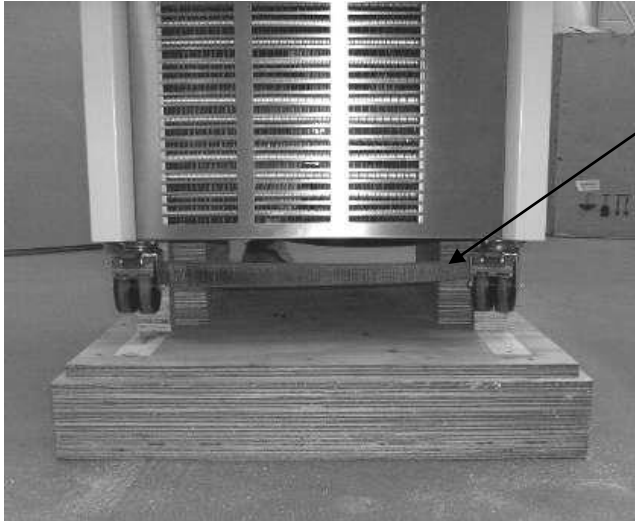

Textile round slings

Align the wheels on the device length.



Textile round slings

5.3.4 Repacking with original packing material

The packaging of a device takes place in the reverse order.

5.4 In-plant transport with hand pellet truck or fork lifter



– The Proline Kryomats can only be positioned diagonally on the conveyor fork.



Transport the device on a hand pallet truck.



Transport the device with a fork lifter.







5.5 Before preparation

- Remove the protective foil.
- For installation and commissioning, the operating instructions must be observed!

6 Preparation

6.1 Assembly and siting

 Warning!	<p>Falling down / falling over of the device on inclined plane / table edge</p> <p><i>Crushing of the hands and feet</i></p> <ul style="list-style-type: none"> • Only position the device on level surfaces and not close to table edges.
 Warning!	<p>Tilting the device by additional load on the device</p> <p><i>Crushing of the hands and feet</i></p> <ul style="list-style-type: none"> • Do not place any heavy parts on the device.
 Caution!	<p>Contact with hot / cold heat transfer liquid</p> <p><i>Scalds, frost bite</i></p> <ul style="list-style-type: none"> • Bring the heat transfer liquid to room temperature before draining. • Drain the heat transfer liquid before transportation. • Disconnect the device from the mains. • If necessary, disassemble accessories...
 Caution!	<p>Skin contact with hot / cold surfaces</p> <p><i>Burns, frost bite</i></p> <ul style="list-style-type: none"> • Bring the surfaces to room temperature before touching them. • Affix the symbol "Hot surface".

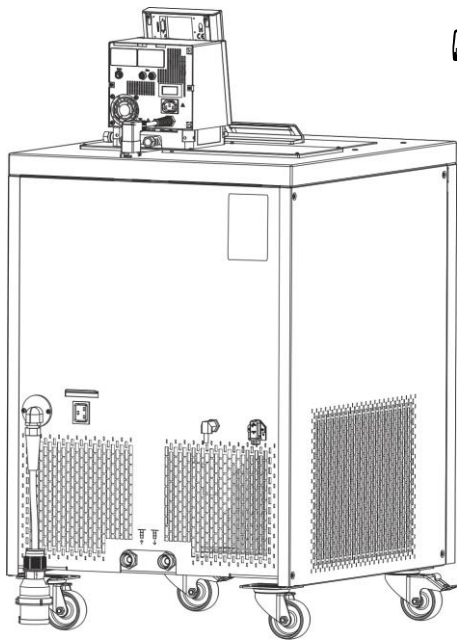

- Site the unit on a flat surface
- The unit must not be put into operation if its temperature during storage or transport has dropped below the dew point. Wait for about one hour.
- The unit may NEVER be overturned nor put upside down!
- Do not cover the ventilation openings at the back of the control head and on all sides of the lower section of the unit.
- Leave at least 40 cm of free space on all sides.
- For operation as bath thermostat, set the bypass valve to internal (operation without external loads) (⇒ 3).
- Plug the mains-cable from the Master control element to the refrigerator unit into the socket 52H on the back of the Kryomat.
- Plug the LiBus connector of the Command remote control into the 70S socket and secure it.
- Plug the LiBus cable from the refrigerator unit also into the socket 70S on the back of the Master control element and secure it.

Operation with external loads

(Circulating thermostat) continue at (⇒ 6.5).



- Check whether the pump connectors at the side and back are fitted with sealing caps (⇒ 3) or that hoses are fitted for external loads.

- Using bath temperatures over 70 °C the supplied self-adhesive label  should be applied on the bath at an easily visible point.
- Do not carry out technical changes on the device!
The edge of the bath must not be drilled!
- It is essential to keep within the permissible ambient temperature range (⇒ 11).
- An increased ambient temperature or increased cooling water temperature reduces the cooling capacity.

6.2 Filling and draining

Filling



Contact with heat transfer liquid when filling / draining
<i>Harmful when inhaled, damage to eyes and skin</i>
<ul style="list-style-type: none"> • Pay attention to the safety data sheet for the heat transfer liquid. • Use CE gloves, protective clothing and eye protection during physical contact with heat transfer liquid. • Avoid splashing the heat transfer liquid. • Make sure that the drain tap is closed before filling.



Use of unsuitable heat transfer liquid
<i>Explosion, burns, scalds, fire</i>
<ul style="list-style-type: none"> • When selecting the heat transfer liquid, observe the admissible temperature range. • Only use LAUDA heat transfer liquids.

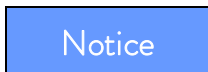

Overfilling containers, spilling heat transfer liquid
<i>Environmental hazard from leaking heat transfer liquid</i>
<ul style="list-style-type: none"> • Note the thermal volume expansion of the heat transfer liquid. • Where necessary, consider the displacement volume of the body being introduced. • Take the volume of external consumers into account.

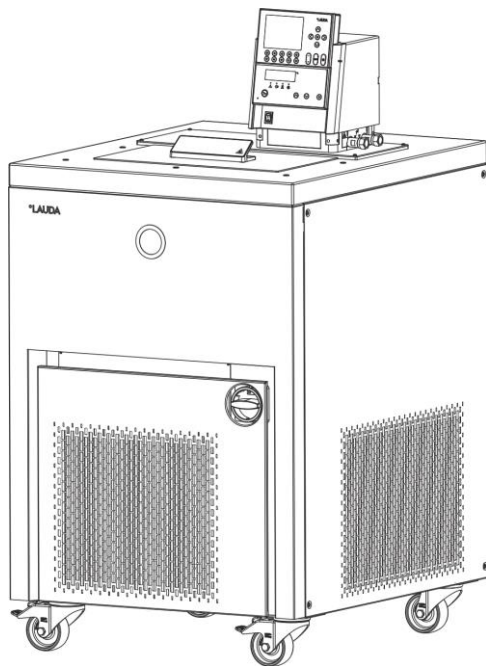

- Close the drain cock.
- Carefully remove all residues of the previous heat transfer liquid (blow dry and remove screw plugs!).
- Maximum filling level is up to 10 mm below the top edge of the bath. Overfilling leads to the display of the warning **LuArn 103** (⇒ 7.12.4). Changes in volume of the heat transfer liquid during temperature changes should be taken into account.
- Best operation is with a level 30-80 mm below the top edge of the bath.
- The cooling pipe of the evaporator should be covered.
- Low-level cut-off occurs at about 95 mm below the top edge of the bath.



- The units are designed for use with non-flammable and flammable liquids to DIN EN 61010-2-010. Flammable heat transfer liquids may only be used below the flash point. (⇒ 6.3).
- When using heat transfer oils note that they expand on heating (approx. 10 %/100 K). With enclosed external loads, the overall expansion takes place in the bath of the Proline Kryomat.
- Ensure that with the connection of an external load, the liquid level does not drop impermissibly due to filling the load → top up with liquid if necessary.
- Set the upper and lower temperature limits (⇒ 7.6.2) in accordance with the limits of the heat transfer liquid in use.

Draining



Contact with hot / cold heat transfer liquid
<i>Scalds, frostbite</i>
<ul style="list-style-type: none"> • Bring heat transfer liquids to room temperature before draining. • Make sure that the drain tap is closed after draining.



Delay in boiling and thermal decomposition due to liquid residues
<i>Burns, scalds, development of harmful vapors</i>
<ul style="list-style-type: none"> • Remove all old heat transfer liquid completely from the bath, external consumers, accessories and hoses. Flush and clean them with new heat transfer liquid.

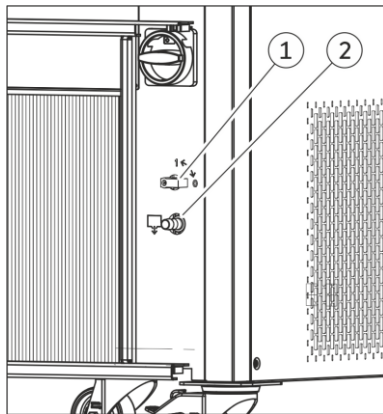

- Switch off the thermostat on the mains switch (rotary switch) withdraw the mains plug.
- The drain tap (1) is located behind the front panel.
- Fit the hose onto the draining nozzle (2).
- Open the drain tap and run off the heat transfer liquid.
- Close the drain tap.



- Follow the regulations for the disposal of used heat transfer liquids.

6.3 Connection of the cooling water

Note that the following conditions apply for the connection of the cooling water supply:

Cooling water pressure (feed - outlet)	maximum 10 bar overpressure
Differential pressure (feed - outlet)	minimum 3.0 bar
Cooling water temperature	10 to 15 °C recommended, 10 to 30 °C admissible (with power restrictions)
Cooling water quantity	see Technical Data (⇒ 11)
Cooling water hose for connection to the device	minimum 13 mm

6.4 Heat transfer liquids, cooling water and hoses

a) Heat transfer liquids

LAUDA designation	Temperature range	Chemical designation	Viscosity (kin)	Viscosity (kin) at temperature	Flash point	Packing drum Order number		
						5 L	10 L	20 L
	from °C to °C		mm ² /s at 20 °C	mm ² /s				
Aqua 90 ①	5 – 90	Decalcified water	1	--	--	LZB 120	LZB 220	LZB 320
Kryo 95	-95 – 60	Silicone oil	1,6	20 at -78 °C	64	LZB 130	LZB 230	LZB 330
Kryo 60	-60 – 60	Silicone oil	3	25 at -60 °C	62	LZB 102	LZB 202	LZB 302
Kryo 51	-50 – 120	Silicone oil	5	34 at -50 °C	120	LZB 121	LZB 221	LZB 321
Kryo 30 ②	-30 – 90	Monoethylene glycol/water mixture	4	50 at -25 °C	--	LZB 109	LZB 209	LZB 309
Kryo 20	-20 – 170	Silicone oil	11	28 at -20 °C	170	LZB 116	LZB 216	LZB 316
Therm 160	60 – 160	Polyalkylene glycol	141	28 at 60 °C	260	LZB 106	LZB 206	LZB 306
Therm 180	0 – 180	Silicone oil	23	36 at 0 °C	250	LZB 114	LZB 214	LZB 314
Therm 250	50 – 250	Silicone oil	158	25 at 70 °C	300	LZB 122	LZB 222	LZB 322



① At higher temperatures → Evaporation losses → Use bath covers.

Only use distilled water or fully demineralized high purity water after adding 0.1 g of soda (Na₂CO₃ sodium carbonate)/ liter of water → Risk of corrosion!

② Water content falls with longer operation at high temperatures → Mixture becomes flammable (flash point 119 °C) → Check the mixture ratio with a hydrometer.

- The use of acidic, aqueous bath liquid or cleaning agents (pH value < 7) is not permissible.
- With the selection of the heat transfer liquid, it should be noted that impairment of the properties is to be expected at the lower limit of the temperature range due to increasing viscosity. Therefore, only make maximum use of temperature ranges when essential.
- Application ranges of heat transfer liquids and hoses are general figures, which may be restricted by the operating temperature range of the units.



With silicone rubber, silicone oils lead to substantial swelling → Never use silicone oil with silicone hoses.

Observe the safety data sheets for the various heat transfer liquids. If required, you can download the safety data sheets from our homepage.

Open the LAUDA homepage, tap ⇒ Services ⇒ Download center.

In the Download center, chose the [Safety data sheet] option in the [Document type] drop-down list.

A list of safety data sheets in PDF format in different languages is displayed.

Tap the relevant safety data sheet.

The download starts and the PDF file is downloaded.

b) Cooling water

Certain requirements are placed on the cooling water with regard to purity. Depending on the cooling water contamination, a suitable method of purification and/or treatment of the water must be employed. The heat exchanger and the complete cooling water circuit can become blocked, damaged and leaky due to unsuitable cooling water. Extensive consequential damage may arise on the whole cooling circuit. The cooling water quality depends on local conditions. If a fault or damage occurs due to unsuitable water quality, it is not covered by our guarantee.

Important: Danger of corrosion of the cooling water circuit due to water of unsuitable quality.

- Free chlorine (e.g. from disinfectants) and water containing chlorine lead to pitting in the cooling water circuit.
- Distilled, deionized or demineralized water is unsuitable due to its corrosive properties and leads to corrosion in the cooling water circuit.
- Seawater is unsuitable due to its corrosive properties and leads to corrosion in the cooling water circuit.
- Water containing iron or iron particles leads to rust formation in the cooling water circuit.
- Due to the high lime content hard water is not suitable for cooling and leads to calcification in the cooling water circuit.
- Cooling water with suspended matter is not suitable.
- Untreated and unpurified river or cooling tower water is not suitable due to its microbiological content (bacteria), which can become deposited in the cooling water circuit.
- Putrid water is not suitable.

Suitable cooling water quality

pH – value	7.5 – 9.0
Hydrocarbonate [HCO ₃ ⁻]	70 – 300 mg/L
Chlorides (Cl ⁻)	< 50 mg/L
Sulfates [SO ₄ ²⁻]	< 70 mg/L
Ratio hydrocarbonate [HCO ₃ ⁻] / sulfates [SO ₄ ²⁻]	> 1.0
Total water hardness	4.0 – 8.5 °dH
Electrical conductivity	30 - 500 µS/cm
Sulfite [SO ₃ ²⁻]	< 1 mg/L
Free chlorine gas (Cl ₂)	< 0.5 mg/L
Nitrates (NO ₃ ⁻)	< 100 mg/L

Ammonia (NH ₃)	Not permissible
Iron (Fe), dissolved	< 0.2 mg/L
Manganese (Mn), dissolved	< 0.05 mg/L
Aluminum (Al), dissolved	< 0.2 mg/L
Free aggressive carbonic acid (CO ₂)	Not permissible
Hydrogen sulfide (H ₂ S)	Not permissible
Algae growth	Not permissible
Suspended matter	Not permissible

Risk to the environment due to oil contamination of the cooling water circuit

With a leaky condenser there is the danger that refrigerating machine oil from the coolant circuit of the cooling thermostat can pass into the cooling water.

Follow all the legal requirements and the regulations of the water supply utility, which apply at the point of use.

Water pollution due to leakage

To avoid pollution due to a leak in the cooling water system it is recommended that a leakage-water detector with a water cut-off is installed.

Servicing intervals

Follow the information for cleaning and decalcifying the cooling water circuit (⇒ 9.3.4.2).

c) Hoses

Elastomer hoses

Hose type	Internal width Ø mm	Temperature range °C	Field of application	Order number
EPDM hose uninsulated	12	10 – 90	For all heat transfer liquids except mineral oils	RKJ 112
EPDM hose insulated	12 External Ø. approx. 35mm	-35 – 90		LZS 021
Silicone hose uninsulated	11	10 – 100	Water, Glycol/water mixture	RKJ 059
Silicone hose insulated	11 External Ø. approx. 35mm	-60 – 100		LZS 007



- EPDM hose is not suitable for mineral oils.
- With silicone rubber, silicone oils lead to substantial swelling → never use silicone oil with silicone hoses.
- Secure hoses against slippage with hose clips.

Metal hoses in non-rusting stainless steel, with union nut M16 x 1, internal width 10 mm.

Type	Length (cm)	Temperature range °C	Field of application	Order number
MK 50	50	-90 – 150	With foam insulation for refrigeration range, for all LAUDA heat transfer liquids	LZM 052
MK 100	100	-90 – 150		LZM 053
MK 150	150	-90 – 150		LZM 054

6.5 Connecting external loads

Notice

Leaks from consumers, hoses and accessories
<i>Environmental hazard from leaking heat transfer liquid</i>
<ul style="list-style-type: none"> Always secure the hoses with suitable safety devices.

Notice

Pump connections not closed off
<i>Environmental hazard from leaking heat transfer liquid</i>
<ul style="list-style-type: none"> Fit sealing plugs to the pump connections when no external consumers are connected and set the flow distribution to internal "INT".

Operation as circulating thermostat



Bursting of the external consumer due to overpressure
<i>Scalding, frostbite, cutting</i>
<ul style="list-style-type: none"> Use a pressure relief device on pressure-sensitive consumers (e.g. glass reactors).

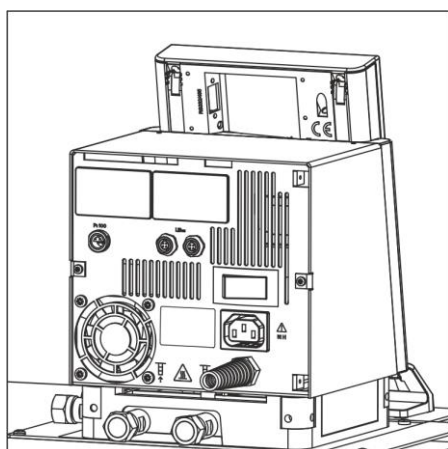

- When used as circulation thermostat, care for shortest hose connections with largest inner diameter as possible. This gives the best flow.
- Push hose with 11 - 12 mm internal width onto hose olive (accessories) or connect metal hoses (⇒ 6.3) to pump connectors.
- Pump connectors at side:
Inlet and outflow ⇒ see labeling housing.
- Pump connectors at back:
Inlet and outflow ⇒ see labeling housing.
- Set bypass valve to "external" (⇒ 3).



- The external application must not have a hydraulically blocking effect.
- If cross-sectional area of tube is too low → temperature gradient between bath and external load due to low flow rate.
- Always ensure the largest possible passages in the external circuit.
- When tightening the union nuts on the pump nipple AF 19, use a wrench AF 14 to counter the tightening torque (see figure).
- If external control is to be used, provide a Pt100 temperature probe in the external load (⇒ 7.5.2 and 7.5.4).



- With loads at a higher position and with stationary pump and ingress of air into the thermostatic circuit, the external volume can drain away, even with closed circuits → Risk of thermostat overflowing!
- Secure hoses against slippage with hose clips.
- Unused pump connectors must be closed off.

7 Starting up



<p>Addition of liquids with low boiling points (e.g. water to hot oil), alteration of liquid properties (reducing the flash point)</p>
<p><i>Explosion, burns, scalds, fire</i></p>
<ul style="list-style-type: none"> • Site the device in suitable premises. • Avoid dripping water and condensation. • Do not position any small parts and liquids above the device. • Keep the cover on the thermostat (if present) closed. • Prevent the ingress of secondary liquids (e.g. from customer's heat exchanger). • Do not work with liquids in the direct vicinity of the device. • Check the heat transfer liquid at least every six months (e.g. mixing ratio with a hydrometer).



<p>Risk of heat transfer liquid overheating due to incorrect entry of overtemperature switch-off point T_{max}.</p>
<p><i>Fire</i></p>
<ul style="list-style-type: none"> • The overtemperature switch-off point must be below the flash point of the heat transfer liquid. Set the overtemperature switch-off point (T_{max}) to 5 K above the upper limit of the temperature range for your application.



<p>Bursting of the external consumer due to overpressure (e.g. glass apparatus)</p>
<p><i>Explosion</i></p>
<ul style="list-style-type: none"> • Install the tubes so that they do not kink. • For consumers with a maximum permissible operating pressure below the maximum pressure of the pump, use a pressure relief device for protection.



<p>Risk of refrigerant circuit bursting from excessive ambient temperatures while device is inoperative</p>
<p><i>Explosion</i></p>
<ul style="list-style-type: none"> • Observe the permitted storage and operating temperatures.



Use of unsuitable heat transfer liquids
<i>Explosion, burns, scalding, fire</i>
<ul style="list-style-type: none"> • Pay attention to the permitted temperature range when selecting heat transfer liquid. • Only use LAUDA heat transfer liquids.



Skin contact with heat transfer liquid or hot / cold surfaces
<i>Burns, scalds, frost bite, impacts, cuts, snagging</i>
<ul style="list-style-type: none"> • Only operate the device with its housing. • Avoid splashes and hand contact with hot or cold heat transfer liquid. • Use CE gloves, protective clothing and eye protection. • Affix the symbol "Hot surface". • Do not touch the connecting and drainage points in the operating state.



Contact with vapors from the heat transfer liquid
<i>Harmful by inhalation</i>
<ul style="list-style-type: none"> • Use an extractor hood. • If possible, use a bath cover.



Bath overflow due to thermal expansion or immersion of objects
<i>Burns, scalds, frostbite</i>
<ul style="list-style-type: none"> • Take the volume of external consumers into account. • Take into account the increase in volume with a rise in temperature.

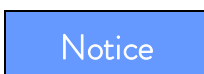

Inadmissible operating temperatures; temperature difference between outflow and product too large
<i>Property damage (consumers, external components)</i>
<ul style="list-style-type: none"> • Note that an externally controlled bath temperature, especially during a transient response, may differ substantially from the set-point temperature. • Note the various limitation options (T_{ih}, T_{il}, T_{max}, correction limitation). • Set the overtemperature switch-off point T_{max} according to the heat transfer liquid. T_{max} must be below the flash point.

7.1 Mains connection

Notice

Use of inadmissible mains voltage or frequency
<i>Property damage</i>
<ul style="list-style-type: none"> Compare the rating label with the available mains voltage and frequency.

Compare the rating on the nameplate (back of control head and behind the front panel) with the mains voltage.

	<ul style="list-style-type: none"> Connect unit only to a socket with a protective earth conductor (PE). No liability is accepted for incorrect mains connections. Ensure that pump connectors without external loads are closed off. Ensure that the unit is filled according to Section 6.2.
---	--

Note for electric installation on site:

Single-phase devices:







Single-phase devices must be protected with a 16 ampere circuit breaker fitted during installation.

Exception: Devices with 13 ampere UK plugs.

Three-phase devices:

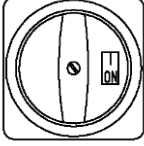
For three-phase devices the rating of the circuit breaker must match the power consumption of the device. The value will be found on the type plate. In each case, select the next higher value. Using an excessively high rated circuit breaker is not permissible.

7.2 Switching on

	<ul style="list-style-type: none"> Check whether the switch at the back of the master control element is in the "On = -" position.
	<ul style="list-style-type: none"> Check whether the switch at the front of the master control element is in the "On = " position.
	<ul style="list-style-type: none"> Set the rotary switch on the front panel to "ON = ". The unit starts operating.
	<ul style="list-style-type: none"> The green LED in the master control element for "Mains ON" is lit.
	<ul style="list-style-type: none"> An acoustic signal is emitted for about 1 second.
	<ul style="list-style-type: none"> It is quite normal if the refrigerating machine makes a rattling sound for a few seconds.

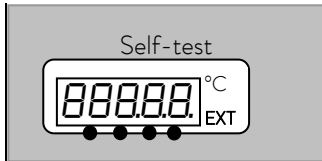

- The unit starts its self-test. All display segments and symbols appear for about 1 second.

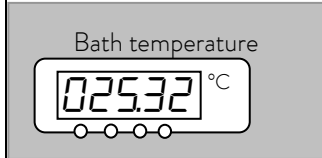

- The momentary bath temperature is displayed,
- the pump starts provided "Standby" or "Manual start" (⇒ 7.6.1) has not been programmed,
- all values are accepted which were active before switch-off.

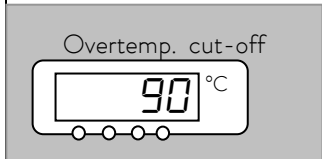

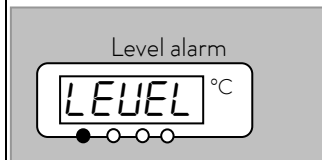

Check or set overtemperature cut-off point:

- The switching point is shown in the LED display on pressing the key .
- Change overtemperature cut-off (⇒ 7.12.1). Overtemperature protection and checking on page 89.
- If necessary, top up heat transfer liquid, this has been pumped out by filling the external load.



- Display for **LEVEL** (low level) appears when the bath has too little liquid.

- Red LED  above the fault triangle  flashes.

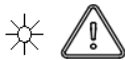

- Find cause of fault and, where necessary, top up missing heat transfer liquid (⇒ 6.3).

- Press the Enter key.

- Also, press the key if unit has been switched off in the fault state.



- No release is possible on Command remote control!

Command

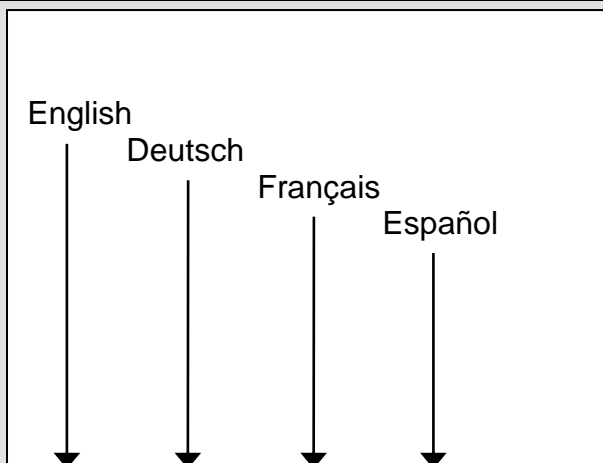
- **Language**





- If the Command remote control is being switched on for the first time, the illustrated window appears automatically, enabling you to select the dialog language with the appropriate soft key.

Display Sounds Master Sounds Command Language Master-Mode Autostart Current Consumpt.	English Deutsch Français Español	– The dialog language also can be changed later via → Settings → Basic settings → Language . – Mark the required language with  or  . – Confirm the selection with  .		
Pump	Menu	End	T _{set}	T _{fix}

7.3 Switching off / standby

Switching off: Set the rotary switch on the front panel to "OFF = 0".

 When switching off only on the master head, using the switch at the front or back, there is still voltage present on the unit or head.



Standby operation: Use the key standby  (⇒ 7.5.3) on the Command remote control. The pump, heating and cooling unit are switched off, but the operating display remains active, so that status displays can be viewed and settings carried out.







 However, a started timer (⇒ 7.10) continues to run. Stop as required with Pause.



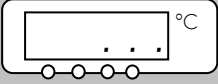

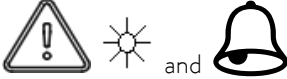
7.4 Key functions

Your Proline Thermostat is easy to operate.

7.4.1 General key functions and pilot lamps

Master	
	Enter key: – From the actual-value display at the main menu level, – activates input, display flashes, – saves input, display ceases to flash and menu point is left, – press for approx. 3 seconds: Exit function and returns to bath temperature display.
 or 	– Paging with keys is possible within the relevant level, or setting of numerical values.

 	<p>Speeds up entry by moving the counting position to the left:</p> <ol style="list-style-type: none"> Keys are pressed and held down or one of the two keys is pressed and held down, followed immediately by brief pressing of the other key. <p>Moves counting position to the right:</p> <ul style="list-style-type: none"> Switching one place to the right occurs by briefly (1 second) releasing the key, followed by another pressing of the key. <p>Useful additional information:</p> <ul style="list-style-type: none"> Two dots in the Master display indicate that a submenu follows. Three dots in the display indicate that a submenu for a module (interface...) or a component (thermostat, Command remote control ...) follows. Module/ component-specific possible settings are only displayed when the hardware is connected. The following always applies: After termination of the relevant settings, they are accepted automatically after approx. 4 s or the setting is accepted immediately with the Enter key.
	<ul style="list-style-type: none"> Fault signal: Flashing red Alarm LED and acoustic signal. An acoustic signal can only sound when it has not been intentionally deactivated! (⇒ 7.6.5).
	<ul style="list-style-type: none"> The bath control occurs via the external temperature probe when the green LED is lit.
	<ul style="list-style-type: none"> Heating is active when the yellow LED is lit.
	<ul style="list-style-type: none"> Cooling is active. When the setpoint temperature is lowered, it may take up to one minute before the blue LED is lit.
	<ul style="list-style-type: none"> The temperature of the external probe is displayed.

Command	
	<ul style="list-style-type: none"> Enter key ("Confirm selection") and go back one level.
	<ul style="list-style-type: none"> Soft key function, to confirm a selection or input and to return to the main display window.
	<ul style="list-style-type: none"> Escape key to quit a window without changes and to go back one level.
	<ul style="list-style-type: none"> Cursor keys for Up, Down, Left and Right.

The diagram shows a control panel with a central display and several physical buttons. At the top, there are two buttons: one with a power symbol and a plus sign, and another with a sun symbol. Below these are two more buttons: one with a minus sign and another with a dot. At the bottom, there are five buttons labeled 'Pump', 'Menu', 'End', 'T_{set}', and 'T_{fix}'. A 'Screen' button is also indicated at the bottom center.

The display is divided into two sections. The left section is titled 'Display' and lists the following menu items: Sounds Master, Sounds Command, Language, Master Mode, Autostart, and Current Consumpt. The right section is titled 'Brightness Contrast' and is currently empty.

Physical buttons are represented by icons: a power button with a plus sign, a sun button, a minus button, and two circular buttons. The display shows a 'T_{set}' button and two 'Soft keys' labeled 'Brightness' and 'Contrast'.

- Standby activation (pump, heater and refrigerating machine are deactivated when the yellow LED is lit). However, timer continues to run! Refer to safety information in ⇒ 7.5.3.

Duo key:

- Top: decimal-point key.
- Bottom: key for arithmetical sign.
- Soft keys: five duo-keys, which each have the function shown in display above them. Soft-key entries are shown framed in the operating instructions. Example: You would like to change the setpoint temperature then press the duo-key under **T_{set}**.
- **Brightness** **Contrast**
- The brightness and contrast can be set on the Command remote control:
- The works setting can be changed via
 - **Settings** → **Basic settings**
 - **Display** → **Brightness** or → **Contrast**.
- The brightness of the LCD illumination can be selected from eight steps or switched off completely.
- The contrast can be set in eight steps.
- There are four different screen displays available. The screen is switched over with the soft key **Screen** :

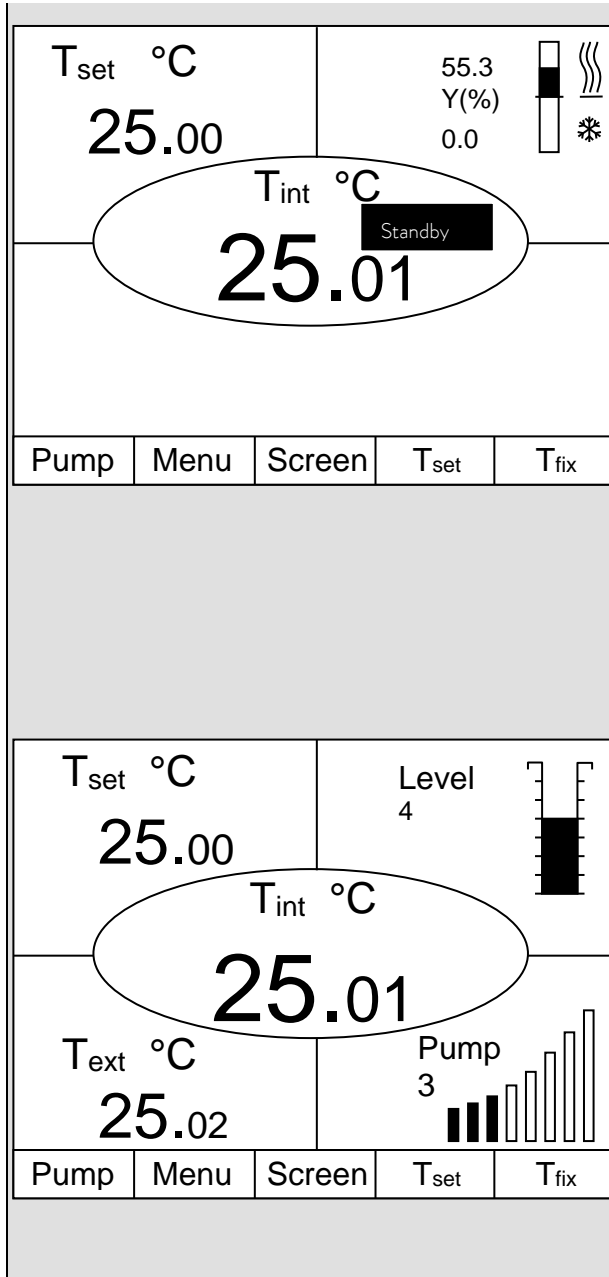

1. **Basic window** with the three most important items of information:

- T_{int} , current bath temperature,
- T_{set} , setpoint of the bath or external temperature,
- Information: Heating/ cooling. Here, e.g. heating is taking place at 55.3% and 0.0% cooling.

Soft keys:

- Pump: Set pump level.
- Menu: Set unit parameters.
- Screen: Changes between basic, normal, super and graphics recorder windows.
- T_{set} : Changes setpoint temperature.
- T_{fix} : Calling and setting of saved setpoints.

2. **Standard window** with five important items of information:

- T_{int} , current bath temperature,
- T_{set} , setpoint,
- T_{ext} , current temperature on external probe (if connected),
- Level of heat transfer liquid in cm above the minimum level,
- Pump level of the Varioflex pump.
- Soft keys like above.

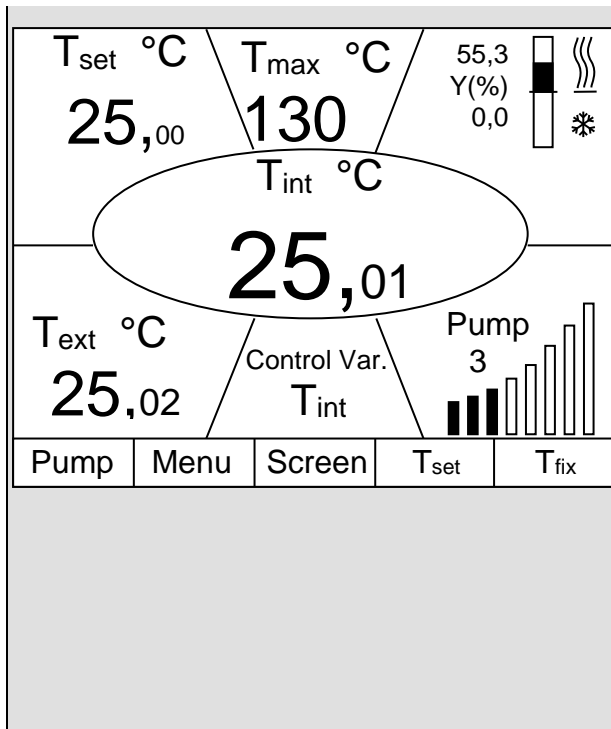

3. Super window with seven items of information:

- T_{int} , current bath temperature.
- T_{set} , setpoint.
- T_{ext} , current temperature on external probe (if connected).
- Overtemperature cut-off point T_{max} .
- Pump level of the Varioflex pump.
- Control variable to T_{int} or T_{ext} .
- Information: Heating / cooling.

Soft keys like above.

4. Graphical measurement display

- All temperature values can be shown graphically against time \Rightarrow 7.7.
- Soft keys like above.

7.4.2 Changing window information

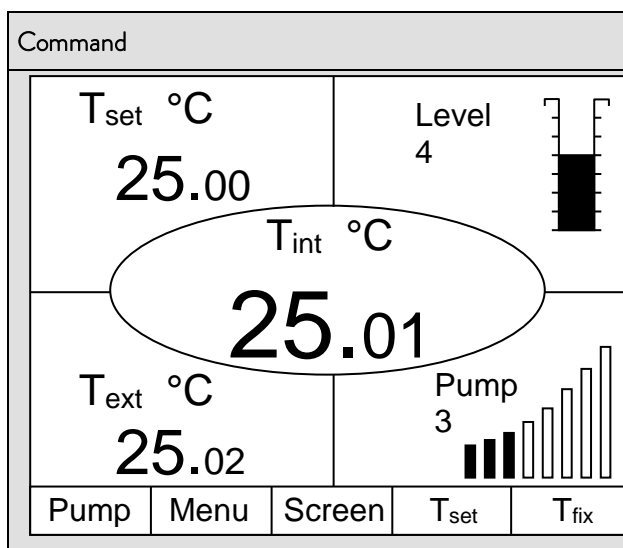

- Display data

- You can adapt the information displayed by your Command remote control to your requirements. For example, if you have not connected any temperature probe, you can exchange it in the standard setting of the normal window for the maximum temperature T_{max} (safety cut-off).
- This is how it is done:

<div style="border: 1px solid black; padding: 5px;"> <p>Basic Window Standard Window Super Window</p> </div> <div style="border: 1px solid black; padding: 5px; margin-top: 5px;"> <p>Edit Default</p> </div> <table border="1" style="width: 100%; border-collapse: collapse; margin-top: 5px;"> <tr> <td style="width: 12.5%;">Pump</td> <td style="width: 12.5%;">Menu</td> <td style="width: 12.5%;">End</td> <td style="width: 12.5%;">T_{set}</td> <td style="width: 12.5%;">T_{fix}</td> </tr> </table>	Pump	Menu	End	T _{set}	T _{fix}	<ul style="list-style-type: none"> - Open the unit parameter menu via the soft key Menu. - With and change from Settings → Display Data → Standard Window → Edit
Pump	Menu	End	T _{set}	T _{fix}		
<div style="border: 1px solid black; padding: 5px;"> <p>Center Up left Up right Down left Down right</p> </div> <div style="border: 1px solid black; padding: 5px; margin-top: 5px;"> <p>T internal T external Setpoint T max Pump step Set value Level Control variable Date/time</p> </div> <table border="1" style="width: 100%; border-collapse: collapse; margin-top: 5px;"> <tr> <td style="width: 12.5%;">Pump</td> <td style="width: 12.5%;">Menu</td> <td style="width: 12.5%;">End</td> <td style="width: 12.5%;">T_{set}</td> <td style="width: 12.5%;">T_{fix}</td> </tr> </table>	Pump	Menu	End	T _{set}	T _{fix}	<ul style="list-style-type: none"> - or takes you to the illustrated window. - and marks T max as illustrated. - Confirm selection with or End, - or quit the window with without any changes being made.
Pump	Menu	End	T _{set}	T _{fix}		

7.4.3 Locking the keyboard

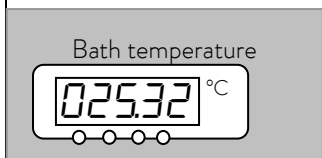
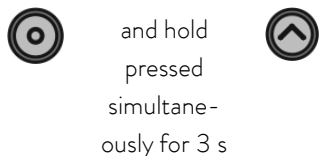
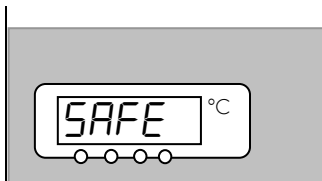

The keyboards of the Master and the Command remote control can be locked independently of one another. This is especially advantageous when the thermostat is positioned in another room and the Command remote control is used as a remote control device. Then the Master keyboard can be locked to prevent unintentional adjustment.

<p>Master</p> <div style="text-align: center; margin-top: 20px;"> and hold pressed simultaneously for 3 s </div> <div style="text-align: center; margin-top: 10px;"> </div>	<p style="text-align: center;">- SAFE</p> <p>Locking:</p> <ul style="list-style-type: none"> - SEt appears for 3 seconds, - then the segments of the first right-hand are formed, - hold both keys pressed until this display is <u>completely</u> visible.
---	---



- **SAFE** flashes briefly and the display returns to the actual temperature.
- The Master keyboard is now locked.
- The **SAFE** display signals the locked state when any Master key is pressed.



Unlocking:

- For three seconds, then **SAFE** appears.
- Then the segments of the left-hand  are formed.
- The actual bath temperature appears again when all the  have been formed.

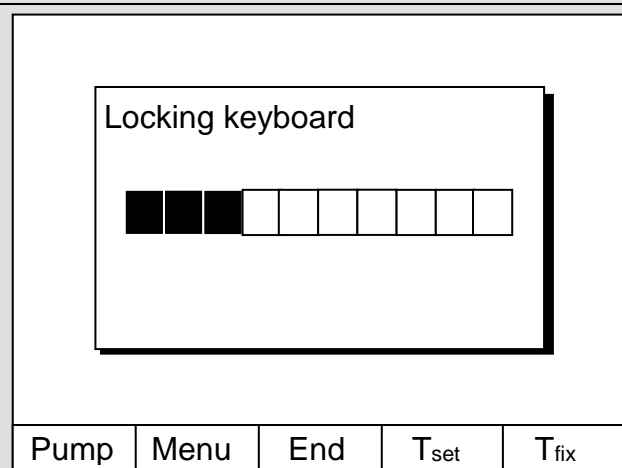
Command





Locking:

- Press  and then  and hold pressed simultaneously for three seconds.
- The locking window appears.
- Hold both keys pressed until the progress bar is completely filled.
- Then the display skips back to the previously set **Screen** mode.
- The soft-key boxes are now blank, indicating that the keyboard is locked.
- On pressing any Master key the display appears:



Unlocking:

- Press  and then  and hold pressed simultaneously for three seconds.
- The unlocking window appears.
- Hold both keys pressed until the progress bar is completely filled.



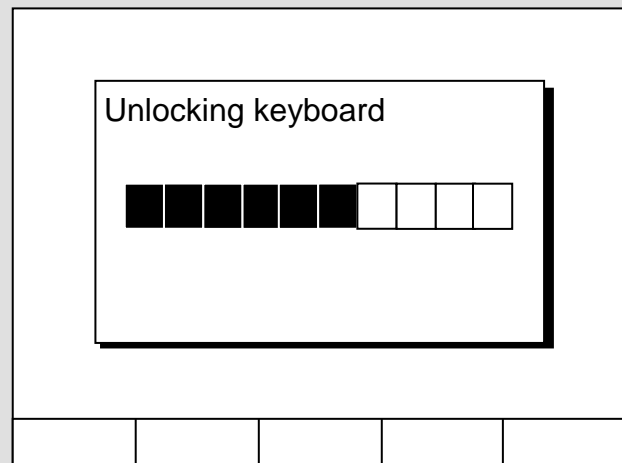



Then the display skips back to the previously set **Screen** mode.



7.5 Important settings

7.5.1 Temperature setpoint setting

The setpoint is the temperature, which the thermostat should reach and maintain constant.

Master (main level)	– <i>SEt</i>
  or   Wait 4 seconds or  	<ul style="list-style-type: none"> – Press key until <i>SEt</i> (Setpoint) appears. – Press key, display flashes. – Enter the setpoint with the two keys (⇒ 7.4.1 General key functions and pilot lamps). – Display flashes 4 seconds → new value is automatically accepted, or value is accepted immediately with Enter key. – For safety reasons the setpoint can only be set up to 2°C above upper limit of the operating temperature range for the relevant device type. – In the following cases, the manual setpoint entry is blocked: Setpoint is taken from the analog module, from the programmer in the Command remote control or via the serial interface. – When the setpoint temperature is to be lowered, it may take up to one minute before the blue LED  lights.

Command

Enter new setpoint:

123,45

Min: -40.00°C Max:202.00°C

1	2	3	4	5
6	7	8	9	0

– T_{set} or T_{fix}

– or the soft key T_{set} opens the setpoint window.

– 123.45 is the setpoint, which is still active. The upper and lower limit temperatures are displayed (device-specific values).

– There are three different possible entry methods:

1. Change the value with the or keys. First, you vary the 1/10°C values. If you hold the key pressed longer, then full degrees change.
2. Enter the complete number with the numerical duo keys and the key for the negative sign and decimal point.
3. Using or , move the flashing cursor line to the decimal place which you would like to change and then change it with or .

– Confirm the value with or quit the window with without having made any changes.

Two other ways of entering the setpoint:

– With the soft key T_{fix} open the window shown on the left.

– The setpoints, which you last entered, are shown in the right-hand column. In the illustrated screen, the last setpoint was 80.0 °C.

– To accept an earlier setpoint, enter the right-hand column with and select the desired value with , then accept it with or cancel with .

– In the left-hand column setpoint temperatures, which are to be used frequently, can be defined as “fixed settings”.

Fixed settings	Recent setpoints
0.00°C	80.00°C
0.00°C	-35.50°C
0.00°C	20.00°C
0.00°C	38.00°C
0.00°C	-35.70°C
0.00°C	0.00°C
0.00°C	0.00°C
0.00°C	0.00°C

Pump	Menu	End	T _{set}	Edit
------	------	-----	------------------	------

Enter new setpoint:

123,45

Min: -40.00°C Max:202.00°C

1	2	3	4	5
6	7	8	9	0

- Select desired position with the cursor keys (black background).
- With the soft key Edit open the window shown on the left.
- Enter fixed temperature setpoint as described above and accept into the list with or cancel with .
- Select and accept values from the list of fixed settings as described above for the "Recent setpoints".

7.5.2 Displaying the actual external temperature

With all Proline Thermostats an external temperature probe can be connected, which for example...

1. ...can be used as an independent temperature measurement channel.
2. ...can be used as the controlled variable for the bath temperature in applications with a noticeable temperature gradient (between the internal bath temperature and an external load). The setup is described in Section 7.5.4. With the function described in the following, you only change over the display.



- External actual temperatures can also be read in by interface modules (⇒ 8).



Connection of the external Pt100 to the Lemo socket 10S

Contact on socket 10S

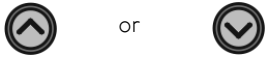
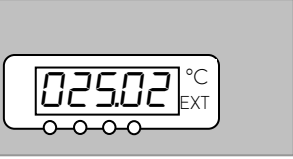
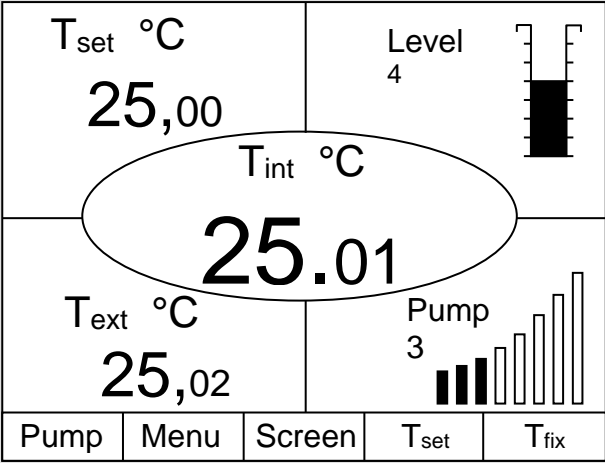

1	+ I	Current circuit		Pt100 DIN EN 60751
2	+ U	Voltage circuit		
3	- U	Voltage circuit		
4	- I	Current circuit		

- Plug: 4-pole Lemosa for Pt100 connection (Order No. EQS 022).
- Use screened connecting leads. Connect screen to plug case.

Master		- EXT
 or		- Switches to the actual-value display of the external temperature probe (or to the actual value received from an interface module ⇒ 7.5.4).
		- EXT is lit in green next to the row of figures. - If no external Pt100 probe is connected, ----- is displayed.
Command		- T _{ext}
		- Provided an external temperature probe is connected, its value is displayed in the lower left part of the standard and super windows (applies to the works setting for the window partitioning). - External actual temperatures can also be read in via interface modules (⇒ 8).
Pump	Menu	Screen
T _{set}	T _{fix}	

7.5.3 Setting pump power or standby

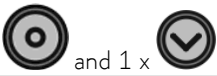
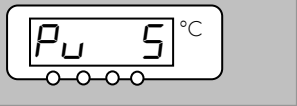
With the Proline Varioflex pump, four pump levels (level five till level eight) are available, with which the bath circulation, flow rate and pressure, the noise generated and the mechanical heat input can be optimized. Pump level eight gives the best bath circulation and temperature homogeneity.

Master		- P_U
 and 1 x		- Call pump power levels display P_U .
		- The current pump level is displayed (here 5).
 or		- The pump levels display flashes.
		- Select pump level (pump speed = pump power): 5 to 8 for pump operation. Pump responds immediately!
		- 0 activates the standby function (pump, heater and refrigerating machine are deactivated).

Wait 4 seconds or



- Display flashes 4 s → new value is automatically accepted, or
- value is immediately accepted with Enter key.

Command

- **Pump Level**

Pump Level				
	Level 8			
	Level 7			
	Level 6			
	Level 5			
	Level 4			
	Level 3			
	Level 2			
	Level 1			
Pump	Menu	End	T _{set}	T _{fix}

- Open the device parameter menu via the soft key Menu.

- Change from **Pump** → **Pump Level** using .

- With or you enter the illustrated window. **Level 5** is active.

- Select another pump level with or and confirm with or **End**,

or quit the window with without making any changes.

- It is not possible to select the pump levels 1 to 4.

Standby activation

- Standby activation (Pump, heater and refrigerating machine are deactivated when the green LED in the lower part of the key is lit).



Please exercise caution when thermostat is in standby mode.









The following settings/ actions may start the thermostat unintentionally from standby mode:



- A previously activated timer mode (⇒ 7.10), because a started timer continues to run!
- "Start" command via interfaces (⇒ 8).

7.5.4 Activate external pump



As an option an external pump is available for the Proline Kryomats for external applications. This pump can be set on / off manually in the menu shown below. Another possibility is the automatic mode. In this case the pump is switched according to the unit status standby / running.



Command	Ext. Pump
<div style="border: 1px solid black; padding: 5px; margin-bottom: 5px;">Ext. pump</div> <div style="border: 1px solid black; padding: 5px; display: inline-block; text-align: center;"> off on auto. </div> <div style="display: flex; justify-content: space-between; margin-top: 5px;"> Pump Menu End T_{set} T_{fix} </div>	<ul style="list-style-type: none"> - Open the device parameter menu via the soft key  Menu. - Change from Pump → Ext. pump using . - With  or  you enter the illustrated window. - Use  or  to switch the pump off, permanently on or to set the automatic mode. Confirm your selection with  or End, - or quit the window with  without making any changes. - Automatic mode means that the external pump is switched off while the unit is in standby mode or it is switched on while the unit is running.

7.5.5 Activating external control

An external temperature probe can be connected to the Proline Thermostats. How this is done is explained in Section 7.5.2. If the bath temperature is to be controlled using this sensor instead of the internal sensor, the setting can be made here.

Furthermore, control can also occur based on the signal from the analog or serial module (⇒ 4.8).

Master	<i>Con</i>
<div style="display: flex; justify-content: space-around; align-items: center;">  and 2 x  </div> <div style="border: 1px solid gray; padding: 5px; margin: 10px 0; text-align: center;"> Con 1 °C </div> <div style="text-align: center; margin-top: 10px;">  </div>	<ul style="list-style-type: none"> - Call the source selection for the control <i>Con</i>. - The momentary setting for the source is displayed, - here <i>1</i> for internal, because control takes place using the temperature signal from the internal temperature probe. - The source display flashes.

 or 

Wait 4 seconds or



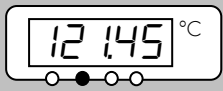

- Change temperature probe source:
- *I* for the internal probe,
- *EP* only when an external probe is connected,
- *EA* only when an analog module is connected and configured,
- *ES* only when a serial module is connected and is continuously receiving actual values from a PC.
- Display flashes 4 s → new value is automatically accepted, or
- value is immediately accepted with Enter key.
- If *EP EA* or *ES* has been selected, then the green  LED indicates that the control has regulated to the external temperature signal.

Command
Control Variable

Control Variable





intern

External Pt100

Analog module

Digital module

Pump
Menu
End
T_{set}
T_{fix}

- Open the device parameter menu with the soft key  Menu.
- With the cursor keys, change further to → Control → Control Variable.
- intern is currently active.
- Select other control variables (only displayed when present) with  or  and confirm with  or End,
- or quit the window with  without making any changes.



7.5.6 Current consumption from the mains

It is not possible to reduce the power consumption of the Proline Kryomats!

Command				
Display Sounds Master Sounds Command Language Master Mode Autostart Current consumpt.		<div style="border: 1px solid black; padding: 5px; text-align: center;">16.0 A</div>		
Pump	Menu	End	T _{set}	T _{fix}
<div style="border: 1px solid black; padding: 10px; margin: 10px auto; width: 80%;"> Max. current consumption (in A): <div style="font-size: 2em; text-align: center;">16,0</div> <hr style="width: 20%; margin: 0 auto;"/> Min: 10.0 A Max: 16.0 A </div>				
1	2	3	4	5
6	7	8	9	0

Current Consumption

- Open the device parameter menu via the soft key  **Menu**.
- With the cursor keys change further to **Settings** → **Basic settings** → **Current Consumpt.**
- 16.0 A** is active.

- Open the settings window with .
- Changes are not accepted!
- Quit the window with .

7.5.7 Setting the date and time

Command
– **Clock** **Time** **Date**

Pump	Set time Set date Timer 1 Timer 2 Format of date
Settings	
Graph	
Clock	
Programmer	
Interfaces	
Control Limits	



- Open the device parameter menu via the soft key  **Menu**.
- With the cursor keys continue to:
→ **Clock** → **Set time**;
- or to **Set date**.

Pump	Menu	End	T _{set}	T _{fix}
------	------	-----	------------------	------------------

Enter time:

15:38:12

1	2	3	4	5
6	7	8	9	0

- Open the settings window with .
- Change the time with cursor or soft keys and accept with .
- or quit the window with  without making changes.
- The date is set just the same with **Set date**.
- The date format (Day Month Year or Month Day Year) can be set under **Format of date**.

7.5.8 Display resolution setting





The Command remote control allows for different resolutions of the displayed temperature.

Command
– **Display resolution**

Pump	Calibration
Settings	Works settings
Graph	Resolution
Clock	Device status
Programmer	Display data
Interfaces	Basic settings
Control	Overlevel handling
Limits	

Pump	Menu	End	T _{set}	T _{fix}
------	------	-----	------------------	------------------

- Open the device parameter menu via the soft key  Menu.
- With the cursor keys continue to Settings → Display resolution.

- Select the desired resolution with  or .
- Accept selection with  or End, or quit the window with  without making any changes.

Resolution	0,1
	0,01
	0,001

Pump	Menu	End	T _{set}	T _{fix}
------	------	-----	------------------	------------------

7.6 Special settings

7.6.1 Defining the type of start mode

Usually it is desirable that the thermostat carries on operating again after an interruption in the voltage supply. However, if for safety reasons you do not wish this, you can insert an intervening manual activation step.

Command
– **Auto start**

Display

Sounds Master

Sounds Command

Language





Master Mode

Autostart

Current consumpt.

Off

On

- Open the device parameter menu via the soft key  **Menu**.
- With the cursor keys continue to:
→ **Settings** → **Basic settings** → **Auto start**.
- **On** is currently active.
- If the standby mode is to be activated after a mains interruption, activate "Off" with  or .
- Accept the change with  or **End**,
- or quit the window with  without making changes.









- When the mains voltage has been restored after an interruption, you can quit the standby mode with .

7.6.2 Defining temperature limits

With this function, it is possible to define a minimum and a maximum temperature in which the thermostat controls. By reaching the temperature limits, a warning appears. In this way setpoint input can be prevented which may damage the heat transfer liquid or the apparatus. For example, if water were used as the heat transfer liquid, +95 °C would be practicable as the maximum temperature and +5 °C as the minimum temperature.







Command					Limits				
Pump Settings Graph Clock Programmer Interfaces Control Limits					T il (min) -50.0 °C T ih (max) 90.0 °C				
Pump	Menu	End	T _{set}	T _{fix}					
Lower limit (T il) <div style="text-align: center; font-size: 2em; font-weight: bold;">-50.0</div> Min: -100.0 °C Max: 202.0 °C									
1	2	3	4	5					
6	7	8	9	0					

- Open the device parameter menu via the soft key  Menu.
- With the cursor keys continue to **Limits**.
- The minimum and maximum temperatures are displayed.
- **T il (min)** is currently active.
- Select the limit to be changed with  or  and confirm with .
- Enter the desired limit temperature.
- Accept the change with ,
- or quit the window with  without making changes.

7.6.3 Setpoint offset operating mode







With this function it is possible to apply an offset value to the temperature provided by the external temperature probe or a module and then to use it as the setpoint. The bath temperature can, for example, be operated at -25 °C below the temperature of a reactor, which is being measured by the external temperature probe.

Command				
<div style="border: 1px solid black; padding: 5px;"> Offset source Setpoint offset </div>		<div style="border: 1px solid black; padding: 5px;"> Off extern Pt100 RS232 </div>		
Pump	Menu	End	T _{set}	T _{fix}
<div style="border: 1px solid black; padding: 5px;"> Offset source Setpoint offset </div>		<div style="border: 1px solid black; padding: 5px;"> 0.00 °C </div>		
Pump	Menu	End	T _{set}	T _{fix}
<div style="border: 1px solid black; padding: 10px; text-align: center;"> Input Setpoint offset: <div style="font-size: 2em; margin: 10px 0;">0.00</div> <hr style="width: 20%; margin: 0 auto;"/> Min: -500.00°C Max: 500.00°C </div>				
1	2	3	4	5
6	7	8	9	0

- **Offset source** and **Setpoint offset**
- Open the device parameter menu via the soft key  **Menu**.
- With the cursor keys continue to **→ Control → Setpoint offset → Offset source**.
- **Off** indicates that the setpoint offset is currently deactivated.
- Select the setpoint source with  or  and confirm with .
- Interfaces (e.g. RS 232) are only displayed if a valid setpoint has already been transmitted.
- With the cursor keys continue to **→ Setpoint offset**.
- The standard value is **0.00°C**.
- Open the left-hand window with .
- Enter the desired temperature.
- Accept the change with .
- quit the window with  without making changes.





7.6.4 Restoring works settings

All works settings, apart from the control parameters and the sensor calibration, are restored.

Command					– Works settings
<div style="border: 1px solid black; padding: 5px; margin-bottom: 5px;"> All modules Master Command Cool </div>	<div style="border: 2px solid black; padding: 5px; margin-bottom: 5px;"> all default only control par. int. only control par. ext. only miscellaneous </div>				<ul style="list-style-type: none"> – Open the device parameter menu via the soft key  Menu. – With the cursor keys continue to → Settings → Works settings. – The window shown opposite appears. – Master and then only control par. int. is shown as a possible choice. There are however various possibilities, which can be selected with  or . – Under All modules Master, Command and all connected modules are reset to the works setting with all default.
Pump Menu End T_{set} T_{fix}					
<ul style="list-style-type: none"> – Under Master you have the choice between: <ul style="list-style-type: none"> – all default, then all Master settings are reset, – only control para. int. for the internal control parameters, – only control para. ext. similar for external, – only miscellaneous which resets setpoint, pump level, maximum current consumption, control to internal and auto start to "Auto". – Under Command all command settings are reset with All default. – Confirm selection with . – Confirm the control dialog shown on the left with  or cancel with . – Return to measurement window with End or . 					
<div style="border: 2px solid black; padding: 10px; margin-bottom: 5px;"> Confirm input! Enter key: Continue Escape key: Cancel </div>					
Pump Menu End T_{set} T_{fix}					



7.6.5 Setting the volume of the acoustic signals

The LAUDA Proline Thermostats signal alarms as a dual-tone acoustic signal and warnings as a continuous tone.

<p>Command</p> <div style="border: 1px solid black; padding: 5px; margin: 10px 0;"> <div style="display: flex; justify-content: space-between;"> <div style="border: 1px solid black; padding: 5px; width: 45%;">Alarm</div> <div style="border: 1px solid black; padding: 5px; width: 45%; background-color: #f0f0f0;"> loud medium low off </div> </div> <div style="display: flex; justify-content: space-between; margin-top: 10px;"> Pump Menu End T_{set} T_{fix} </div> </div>	<p>– Sounds</p> <ul style="list-style-type: none"> – Open the device parameter menu via the soft key  Menu. – With the cursor keys continue to → Settings → Basic Settings → Sounds. – Select either Alarm or Warning. – Example on left: Alarm is set to loud. – Select the desired volume with  or . – Accept selection with  or End or quit the window with  without making changes.
--	--

7.6.6 Entering the offset of the internal temperature probe

If, during checking with a calibrated reference thermometer a deviation is found, then the offset (i.e. the additive part of the characteristic) of the internal measuring chain can be adjusted with the following function. The reference thermometer must be dipped into the bath according to the details on the calibration certificate.



<p>Command</p> <div style="border: 1px solid black; padding: 5px; margin: 10px 0;"> <div style="display: flex; justify-content: space-between;"> <div style="border: 1px solid black; padding: 5px; width: 45%;"> intern Pt100 extern Pt100 </div> <div style="border: 1px solid black; padding: 5px; width: 45%; background-color: #f0f0f0;"> Calibration Default </div> </div> <div style="display: flex; justify-content: space-between; margin-top: 10px;"> Pump Menu End T_{set} T_{fix} </div> </div>	<p>– Calibration</p> <ul style="list-style-type: none"> – Open the device parameter menu via the soft key  Menu. – With the cursor keys continue to → Settings → Calibration → intern Pt100 → Calibration. – The window shown on the left appears. – Confirm selection with .
---	---

Temperature value of the ref.
temp. measurement device:

20,15

Min: -50.0°C Max: 302.00

1	2	3	4	5
6	7	8	9	0

- The temperature measurement device shows the true temperature value (with glass thermometers consider the correction where applicable!).
- Change the display in the adjacent window to the true value with cursor or soft keys and accept with  or End ,
- or quit the window with  without making changes.

7.6.7 Restoring the works setting of the internal temperature-probe offset

If the offset has been misadjusted unintentionally, the works setting can be restored with this function.

Command

intern Pt100
extern Pt100

Calibration
Default





Pump	Menu	End	T _{set}	T _{fix}
------	------	-----	------------------	------------------

Confirm input!

Enter key: Continue



Escape key: Cancel

Pump	Menu	End	T _{set}	T _{fix}
------	------	-----	------------------	------------------

- Default
- Open the device parameter menu via the soft key  Menu .
- With the cursor keys continue to → Settings → → Calibration → → intern Pt100 → → Default .
- The window shown adjacent appears.
- Confirm selection with  .
- Confirm the control dialog on the right with  or cancel with  .
- Return to the measurement window with End or  .



7.6.8 Entering the offset of the external temperature probe

If a deviation is found during the check using a calibrated reference thermometer, then the offset (the additive part of the characteristic) of the external measurement chain can be adjusted with the following function. The reference thermometer must be dipped nearly by the external temperature probe into the consumer bath according to the details on the calibration certificate.

Command					– Calibration
intern Pt100 extern Pt100		Calibration Default			– Open the device parameter menu via the soft key  Menu .
					– With the cursor keys continue to → Settings → Calibration → extern Pt100 → Calibration .
					– The adjacent window appears.
					– Confirm selection with  .
					– Continue as described in (⇒ 7.6.6) for the internal temperature probe.
Pump	Menu	End	T _{set}	T _{fix}	

7.6.9 Restoring the works setting of the external temperature-probe offset

If the offset has been misadjusted unintentionally, the works setting can be restored with this function.

Command					– Default
intern Pt100 extern Pt100		Calibration Default			– Open the device parameter menu via the soft key  key  Menu .
					– With the cursor keys continue to → Settings → Calibration → extern Pt100 → Default .
					– The adjacent window appears.
					– Confirm selection with  .
					– Continue as described in (⇒ 7.6.7) for the internal temperature probe.
Pump	Menu	End	T _{set}	T _{fix}	

7.7 Graphical display of temperature measurements

Command					– Screen and Graph																
<div style="display: flex; justify-content: space-between; border-bottom: 1px solid black;"> T_{set}25.00 — T_{int}25.01 — T_{ext}25.02 </div> <div style="border: 1px solid black; padding: 5px; margin: 5px 0;"> </div> <div style="display: flex; justify-content: space-around; border-bottom: 1px solid black; font-size: small;"> Pump Menu Screen T_{set} Graph </div>					<ul style="list-style-type: none"> – Press the soft key Screen a number of times as required until the graph recorder window appears. – With the soft key Graph you enter the menu for the configuration of the graph recorder. – Mode defines, – whether the recording is to run continuously as Online graph, – or whether it is to be started with Start record and later terminated with Stop record. When this start/stop mode is active, Rec flashes at the top left of the display. – Displayed value defines, – which of the measurements T_{int}, T_{set} and/or T_{ext} is to be graphically displayed. In the menu all combinations are offered. – Legend defines, – whether the axis label is to be invisible or visible. – Sample time defines with which time interval the measurements are recorded. 5 possibilities are offered: <ul style="list-style-type: none"> – From 2s (max. 1h45min) up to 2min (max. 105h). – Time axis defines over which time range the measurements are to be displayed. – With Automatic the program finds the optimum display. – Manual input from 9min up to 144h. – Time base defines whether scaling is to be carried out. – With Relative the start occurs at 00:00:00. – With Absolute the current time is displayed. 																
<table border="1" style="width: 100%; border-collapse: collapse; font-size: x-small;"> <tr> <td style="width: 30%; padding: 2px;">Mode</td> <td style="padding: 2px;">Online graph</td> </tr> <tr> <td style="padding: 2px;">Displayed value</td> <td style="padding: 2px;">Start Record</td> </tr> <tr> <td style="padding: 2px;">Legend</td> <td style="padding: 2px;"></td> </tr> <tr> <td style="padding: 2px;">Sample Time</td> <td style="padding: 2px;"></td> </tr> <tr> <td style="padding: 2px;">Time axis</td> <td style="padding: 2px;"></td> </tr> <tr> <td style="padding: 2px;">Time base</td> <td style="padding: 2px;"></td> </tr> <tr> <td style="padding: 2px;">Temp. scale</td> <td style="padding: 2px;"></td> </tr> <tr> <td style="padding: 2px;">Temp. limits</td> <td style="padding: 2px;"></td> </tr> </table>					Mode	Online graph	Displayed value	Start Record	Legend		Sample Time		Time axis		Time base		Temp. scale		Temp. limits		
Mode	Online graph																				
Displayed value	Start Record																				
Legend																					
Sample Time																					
Time axis																					
Time base																					
Temp. scale																					
Temp. limits																					
<table border="1" style="width: 100%; border-collapse: collapse; font-size: x-small;"> <tr> <td style="width: 30%; padding: 2px;">Mode</td> <td style="padding: 2px;">Tset Tint Text</td> </tr> <tr> <td style="padding: 2px;">Displayed value</td> <td style="padding: 2px;">Tset Tint</td> </tr> <tr> <td style="padding: 2px;">Legend</td> <td style="padding: 2px;">Tset Text</td> </tr> <tr> <td style="padding: 2px;">Sample time</td> <td style="padding: 2px;">Tint Text</td> </tr> <tr> <td style="padding: 2px;">Time axis</td> <td style="padding: 2px;">Tint</td> </tr> <tr> <td style="padding: 2px;">Time base</td> <td style="padding: 2px;">Text</td> </tr> <tr> <td style="padding: 2px;">Temp. scale</td> <td style="padding: 2px;">Tset</td> </tr> <tr> <td style="padding: 2px;">Temp. limits</td> <td style="padding: 2px;"></td> </tr> </table>					Mode	Tset Tint Text	Displayed value	Tset Tint	Legend	Tset Text	Sample time	Tint Text	Time axis	Tint	Time base	Text	Temp. scale	Tset	Temp. limits		
Mode	Tset Tint Text																				
Displayed value	Tset Tint																				
Legend	Tset Text																				
Sample time	Tint Text																				
Time axis	Tint																				
Time base	Text																				
Temp. scale	Tset																				
Temp. limits																					
<table border="1" style="width: 100%; border-collapse: collapse; font-size: x-small;"> <tr> <td style="width: 30%; padding: 2px;">Pump</td> <td style="padding: 2px;">Menu</td> <td style="padding: 2px;">End</td> <td style="padding: 2px;">T_{set}</td> <td style="padding: 2px;">T_{fix}</td> </tr> </table>					Pump	Menu	End	T _{set}	T _{fix}												
Pump	Menu	End	T _{set}	T _{fix}																	

Mode Displayed value Legend Sample Time Time axis Time base Temp. scale Temp. limits	Temp. min 22.00 Temp. max 27.00										
<table border="1" style="width: 100%; border-collapse: collapse;"> <tr> <td style="width: 15%;">Pump</td> <td style="width: 15%;">Menu</td> <td style="width: 15%;">End</td> <td style="width: 15%;">T_{set}</td> <td style="width: 15%;">T_{fix}</td> </tr> </table>		Pump	Menu	End	T _{set}	T _{fix}					
Pump	Menu	End	T _{set}	T _{fix}							
<div style="border: 2px solid black; padding: 10px; width: fit-content; margin: 0 auto;"> <p>y-axis Limit:</p> <h2 style="margin: 0;">22.00</h2> <p>Min: -150.00°C Max: 26.90 °C</p> </div>											
<table border="1" style="width: 100%; border-collapse: collapse;"> <tr> <td style="width: 20%;">1</td> <td style="width: 20%;">2</td> <td style="width: 20%;">3</td> <td style="width: 20%;">4</td> <td style="width: 20%;">5</td> </tr> <tr> <td>6</td> <td>7</td> <td>8</td> <td>9</td> <td>0</td> </tr> </table>		1	2	3	4	5	6	7	8	9	0
1	2	3	4	5							
6	7	8	9	0							

- **Temp. scale** defines how the scaling is to be carried out:
- **automatic**, by the program, or
- **manual** in that you yourself define the limits with the next menu point.
- The min. and max. values for the graphical display are manually entered with **Temp. limits**.
- **Temp. min 22.00°C** is the momentary minimum value.
- **Temp. max 27.00°C** is the momentary maximum value.
- The highlighted value can in each case be changed with . Enter the desired new value in the changes window in the usual way.
- When setting the minimum value, the largest permissible value (here 26.90 °C, since the maximum value is 27 °C) is stated.
- When setting the maximum value, it is conversely the minimum value, which is entered.
- However, if a value is entered which exceeds the other corresponding limit, then this warning is issued:
Warning: Value not in input range.

7.8 Programmer

Almost any temperature/time profile can be created with the programmer. A desired bath temperature can be approached as quickly as possible or via a defined ramp. Furthermore, the pump level and the behavior of the switching outputs can be defined. Five temperature/time programs are provided for free programming. Each program consists of a number of temperature/time segments. Also included are details of how often the program is to be executed (loops). The sum of all segments of all programs may be up to a maximum of 150. A warning is given if the creation of more than 150 segments is attempted.

Typical segments are:

Ramp: If a time is specified, then the segment is a ramp, which is described by the target temperature, i.e. the temperature at the end of the segment, and the duration from the start to the end of the segment.

Step: Without any specified time the final temperature is approached as quickly as possible.

Temperature hold phase: No temperature change (i.e. the temperatures at the start and end of a segment are the same).



The programmer can be controlled or changed via the RS 232 interface, the timer or switching contacts.

7.8.1 Program example

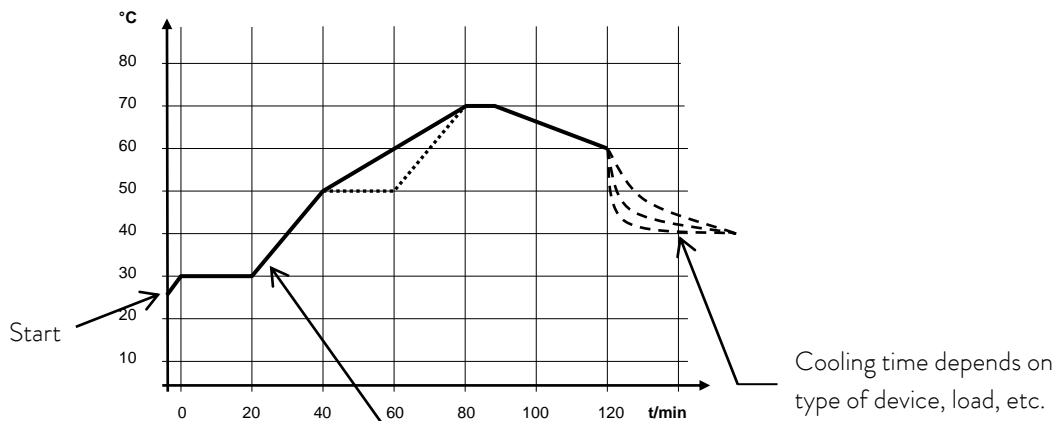

Real program example with 6 segments

No	T end °C	Time [h:m]	Tolerance	No	Pump	Out 1	Out 2	Out 3	
Start	30.00°C	-----	0.00°C	Start	-----	-----	-----	-----	
1	30.00°C	00:20	0.10°C	1	2	-----	-----	-----	
2	50.00°C	00:20	0.00°C	2	3	-----	-----	-----	
3	70.00°C	00:40	0.00°C	3	4	-----	-----	-----	
4	70.00°C	00:10	0.10°C	4	2	-----	-----	-----	
5	60.00°C	00:30	0.00°C	5	2	-----	-----	-----	
6	30.00°C	00:00	0.00°C	6	2	-----	-----	-----	
Pump	Menu	End	Insert	Delete	Pump	Menu	End	Insert	Delete



Each program begins with the segment "Start". It defines at which temperature Segment 1 is to continue the program. It is not possible to specify a time for the Start segment. For thermostats without cooling ability, the start temperature must be selected higher than the bath temperature, which prevails before the program start. Without the Start segment, Segment 1 would be different depending on the bath temperature at the start of the program.

Edited program example (see dashed curve in the graph on previous page).

No	T end °C	Time [h:m]	Tolerance
Start	30.00°C	-----	0.00°C
1	30.00°C	00:20	0.10°C
2	50.00°C	00:20	0.00°C ③
3①	50.00°C ①	00:20 ②	0.10°C ③
4	70.00°C	00:20 ②	0.00°C
5	70.00°C	00:10	0.80°C ③
6	60.00°C	00:30	0.00°C
7	30.00°C	00:00	0.00°C
Pump	Menu	End	Delete

No	Pump	Out 1	Out 2	Out 3
Start	-----	-----	-----	-----
1	2	-----	-----	-----
2	2	-----	-----	-----
3	2	-----	-----	-----
4	2	-----	-----	-----
5	2	-----	-----	-----
6	2	-----	-----	-----
7	2	-----	-----	-----
Pump	Menu	End	Delete	Delete

① Insert new segment (⇒ Section 0)

② ③ Change segment time or tolerance (⇒ Section 0)



The field tolerance (refer to the above program table and the graph below):

- It facilitates exact conformance to the dwell time at a specified temperature. Segment 1 is not processed until the bath temperature is within the tolerance range ❶, so that the ramp (Segment 2) starts delayed at ❷.
- A tolerance range which is too tight can however also cause undesired delays. In particular with external control the range should not be chosen too tightly. In Segment 5 a larger tolerance has been entered, so that the desired time of ten minutes is maintained even with settling action ❸.
- Only flat (slow) ramps should be programmed where necessary with a tolerance range. Steep ramps which lie close to the maximum possible heating or cooling rates of the thermostat may be severely delayed by a tolerance range that is too tight (here in Segment 2) ❹.

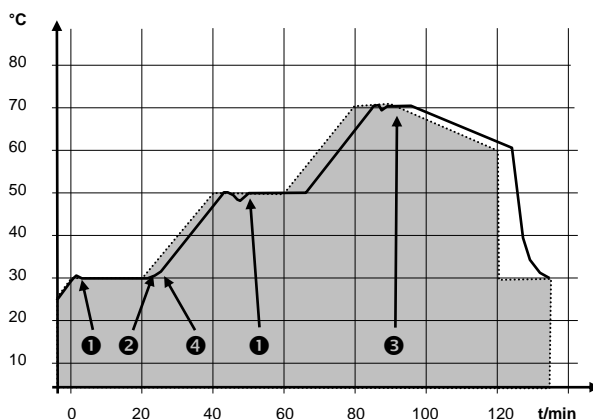

Example for the influence of the tolerance field input in case of external bath temperature control:

The setpoint temperature of the programmer is shown in grey.

The actual temperature in the external bath container is represented as a continuous line.

7.8.2 Selecting and starting the program (Start, Hold, Stop)

Here you will learn how to select and start a program that has already been created. If no program has been created (⇒ 7.8.4) “Creating or modifying a program (Edit)”.

Command
– Programmer Program 1

Pump
Settings
Graph
Clock
Programmer
Interfaces
Control
Limits



Program 1
Program 2
Program 3
Program 4
Program 5
Ramp function

Pump
Menu
End
T_{set}
T_{fix}

Status
Edit
Loops
Graph
Info

Start

Pump
Menu
End
T_{set}
T_{fix}

- Open the device parameter menu via the soft key   Menu .
- With the cursor keys continue to:
→ Programmer → Program 1 .
- Confirm with the key .

- The submenu Status appears.
- Using the Status menu, the selected program can be:
 1. started Start ,
 2. paused Hold ,
 3. continued Continue or
 4. terminated Stop .



In addition, the standby key  stops the programmer! (Pause operation).
After standby is deactivated, the programmer goes on!

Commands, which, depending on the situation, cannot be executed, are not displayed. Continue therefore only appears when Hold has been activated.





Status	Hold		
Edit	Stop		
Loops			
Graph			
Info			
Pump	Menu	End	Prog.1 running

- Once the start has been confirmed with , **Prog. 1 running** appears at the bottom.

7.8.3 Interrupting, continuing or terminating the program (Hold, Continue, Stop)

Command	Programmer	Program 1	Status
---------	------------	-----------	--------



Status	Hold		
Edit	Stop		
Loops			
Graph			
Info			
Pump	Menu	End	Prog.1running

- After a program has been started by pressing the  key, the command options **Hold** or **Stop** are shown.
- Here, with the aid of the keys  or  and  the running program can be paused with **Hold** or terminated with **Stop**.
- Once the program has been terminated, the device runs with the last setpoint setting.

Status	Continue		
Edit	Stop		
Loops			
Graph			
Info			
Pump	Menu	End	Prog.1Standby

- Continuation of a program paused with **Hold** occurs using **Continue** which is obtained with .

Status	Continue		
Edit	Stop		
Loops			
Graph			
Info			
Pump	Menu	End	Pr. 1 Standby

- In addition, the standby key  stops the programmer. The pump, heater and cooling unit are switched off. Follow the safety information (⇒ 7.5.3).
- After pressing the standby key  again, the programmer returns to the previously selected operating mode: Pause or active operation depending on what was previously selected.

7.8.4 Creating or modifying a program (Edit)

Here, there are the following functions:

- Entry of a program.
- Display of the program data of a saved program and modification of the segment data.
- Insertion or appending of a new segment.
- Deletion of a segment.



- In addition, when a program has just been executed, new segments can be inserted and existing ones modified, even the currently active segment. Furthermore, all segments, except the currently active one, can be deleted at any time.
- Modifications to the currently running segment are possible. The segment then continues as though the modification had been applicable since the start of the segment.

However: If the new segment time is shorter than the segment time that has already run, then the program skips to the next segment.

- If a segment time >999h: 59min is required, then this time period must be shared over a number of consecutive segments.

Entering a program:

Program example (⇒ 7.8.1)

Command
Programmer Program1 Edit **Modify**

Status

Loops

Graph

Info

Modify

Delete

Pump

Menu

End

T_{set}

T_{fix}

No.	T end °C	Time [h:m]	Tolerance
Start	30.00°C	-----	3.00°C
1	30.00°C	00:30	3.00°C

Pump

Menu

End

Insert

Delete

- In the "Edit" menu one can **Modify** or **Delete** a program.
- Press the key.
- Continue to **Modify** with the key .
- There is the possibility of modifying single segments, i.e. segments can be entered as new, changed and also deleted.
- In the "Start" line enter in the field "T end °C" the temperature at which the sequence is to start (default value is 30 °C). A time entry is not possible in the "Start" segment, because the thermostat immediately executes Segment 1 on reaching the start temperature.
- Delete single segments (rows) with **Delete**.
- For thermostats without cooling ability, the setpoint temperature must be obtainable, i.e. above the bath temperature displayed at the time of the program start.

- Using the cursor keys move the black background to the field, which you would like to change. It can be edited by pressing the key (see following pages).
- The soft key **Insert** inserts in the marked line a new segment that has a default value taken from the previous segment with the exception of the Tolerance field. The Tolerance is always specified as 0.00. All following segment lines will be moved one line downwards.
- In the above window Segment 1 was created in this way.
- Continue with to the fields ⇒ "Time" ⇒ "Tolerance". See program example in 7.8.1.
- If there is no entry in the "Time" field, the bath temperature is approached as quickly as possible. With a time entry the final temperature is obtained exactly after the time expires (ramp).
- The entry in the field "Tolerance" field defines how accurately the final temperature is to be obtained before the next segment is processed.

If the tolerance range has been selected too small, it may be that the program does not continue, because the required tolerance is never achieved.

External temperature control: Especially with ramps, a too close tolerance range can cause undesired delays in the start phase of the ramp.

Temp. tolerance (0=off):









10.00

Min: 0.00°C Max:450.00°C







1	2	3	4	5
6	7	8	9	0

Pump level	Level 8
	Level 7
	Level 6
	Level 5
	Level 4
	Level 3
	Level 2
	Level 1

Pump	Menu	End	T _{set}	T _{fix}
------	------	-----	------------------	------------------

- If the field in the column "Tolerance" has a black background, the entry mode for the "Temperature tolerance" is obtained by pressing the  key. It defines how accurately the end of segment temperature is to be obtained before the next segment is processed. A tolerance which is selected too small can stop the next segment from being started according to plan.
- Set the temperature tolerance and confirm with .
- Continue with  to the entry field "Pump".
- If the field in the column "Pump" has a black background, the entry mode for the **Pump level** is obtained by pressing the key .
- With  or  select Pump Level 5 - 8 or "-----" and confirm with . "-----" stands for "no change to previous segment", i.e. when "-----" is present in all fields, the pump level always retains the start setting or the setting before the program start.
- Continue with  to the field "Out 1", "Out 2" or "Out 3".

Contact out				
<div style="border: 1px solid black; padding: 5px;"> <p>-----</p> <p>open</p> <p>closed</p> </div>				
Pump	Menu	End	Tset	Tfix

- The contact outputs of the contact module (if present, special accessory) are programmed here.
- If the field in the column "Out 1" has a black background, the entry mode for the **Contact output** is obtained by pressing the  key.
- With  or  select -----, **Open** or **Closed** and confirm with . ----- stands for no change with respect to the previous segment, i.e. if ----- is present in all fields, the contact setting of the start setting or that from the program start is retained.
- If applicable, continue with  to "Out 2" and "Out 3".
- Programming is terminated with  or .

7.8.5 Defining the number of program loops (Loops)

Programmer Program1 Loops

Status	1
Edit	
Loops	
Graph	
Info	

- If required, programs can be looped many times.
- With and access the menu **Loops**.
- Select the number of desired program loops.

Pump	Menu	End	T _{set}	T _{fix}
------	------	-----	------------------	------------------

Loops (0=infinite)

1

Min: 0 Max:255

- Press the key, set the required number. Entering 0 causes the program to repeat continuously.
- Confirm the entry with the key and return to the display.
- You can quit the Edit mode with or **End**.

1	2	3	4	5
6	7	8	9	0

7.8.6 Viewing the program sequence as a graph (Graph)



Programmer Program1 Graph

Status	Show chart
Edit	
Loops	
Graph	
Info	

- takes you to the submenu **Graph**.
- Press the key ⇒ **Show chart** and .
- The program sequence is shown.

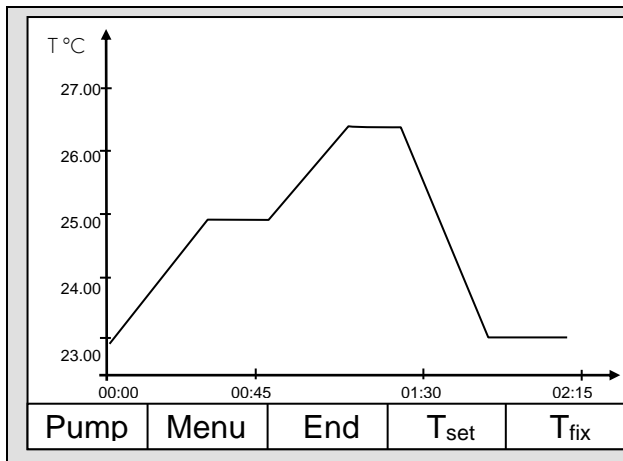
Pump	Menu	End	T _{set}	T _{fix}
------	------	-----	------------------	------------------



- The display of the programmed temperature curve can be quit with  or .

7.8.7 Obtaining information on a program (Info)

Command



Status	Segments 2
Edit	Temp.min 20.00°C
Loops	Temp.max 40.00°C
Graph	Duration 01:00
Info	Seg. free 145
	Actual Seg. 5
	Seg. Remain 00:05
	Loop actual 3

Pump Menu End **Prog.1 Standby**

- **Programmer** **Program1** **Info**

- Continue with  to **Info**.
- Here, all information is displayed about the entered program sequence.
- Number of segments.
- Minimum temperature in °C.
- Maximum temperature in °C.
- Program duration in hh: mm (without the time, which is necessary to process step changes in temperature).
- Number of free segments.
- Segment, which is at present (currently) being processed.
- Residual time of the current segment in hours and minutes.
- Current pass; in the example the third of all passes is running.

The last three points are only displayed when a program runs.

- Quit the window with  or .

7.9 Ramp function

With the ramp function, temperature changes over any time period can be conveniently entered. This is especially advantageous with very low temperature changes (e.g. 0.1 °C/ day).

Example: From the current outflow temperature (e.g. 242.4 °C) 200 °C of cooling is to occur over 5 days.

Then 200 °C is entered as the temperature change, the time value 5 is entered for the time and day(s) selected as the time unit.



The ramp function is executed until it is manually terminated or until the temperature limits T_{il} (min) or T_{ih} (max) described in Section 7.6.2 are attained.

Command				
Pump	Menu	End	T_{set}	T_{fix}
Pump	Menu	End	T_{set}	T_{fix}

Status				
Pump	Menu	End	T_{set}	T_{fix}
Pump	Menu	End	T_{set}	T_{fix}

Command

- Pump
- Settings
- Graph
- Clock
- Programmer
- Interfaces
- Control
- Limits

Program List

- Program 1
- Program 2
- Program 3
- Program 4
- Program 5
- Ramp function**

- **Ramp function**
- Open the list of device parameters using the soft key Menu.
- With the cursor keys continue to **Programmer** → **Ramp function**.
- Confirm with the key .

Status

- Temp. change
- Time
- Time unit



Time Unit Selection

- Second(s)
- Minute(s)
- Hour(s)
- Day(s)**

- Enter a positive or negative temperature value with **Temp. change**.
- With **Time** enter a figure (without time unit).
- With **Time unit** choose between **Second(s)** up to **Day(s)**.
- Under **Status** the ramp is started → **Start** or stopped → **Stop**.
- When the ramp function is being executed, **Ramp active** appears in the window bar.
- Without manual switch-off the ramp terminates at the latest at T_{il} (min) or T_{ih} (max).

7.10 Timer function

Using the timer function, the thermostat can carry out an action at a certain time or after a certain waiting period. The actions are: switching on the thermostat, entering the standby mode or one of the 5 programs in the programmer.

Command					– Clock Timer 1 Timer 2
Pump Settings Graph Clock Programmer Interfaces Control Limits	Set time Set date Timer 1 Timer 2 Format of date	<ul style="list-style-type: none"> – Open the device parameter menu via the soft key  Menu . – With the cursor keys continue to: → Clock → Timer 1 , – or to Timer 2 , – with the menu Status the selected timer is switched off or on . – The standby key  does not stop the timer! 			
	<p>Please exercise caution when thermostat is in standby mode. (⇒ 7.5.3) A previously activated timer mode could unintentionally start the thermostat again from the standby mode.</p>				
Status Function Action Set Time Set Date	Weekplan Time absolute Time relative	<ul style="list-style-type: none"> – The menu Function is used to define when an action is executed: – Similar to an electronic mains timer, Weekplan enables two switching events to be carried out each day. The cycle is repeated after 7 days. – Time absolute defines a time and a date on which a once-only action (switching event) occurs. The time point is set with Set time and with Set date . – Time relative defines a waiting period after which a once-only action occurs. With Set time up to 99h: 59min can be entered. ("Set date" is masked out with this function selection). – If the Weekplan is activated, in this window only Status , Function and Weekplan are displayed. 			
Pump Menu End T _{set} T _{fix}	Pump Menu End T _{set} T _{fix}				

Weekplan				
	Time	Action	Time	Action
Monday	07:30	Start	17:00	-----
Tuesday	10:00	Prog.4	17:00	-----
Wednesday	08:00	-----	17:00	-----
Thursday	08:00	-----	17:00	-----
Friday	08:00	-----	16:00	Standby
Saturday	08:00	-----	17:00	-----
Sunday	08:00	-----	17:00	-----
Pump	Menu	End	T _{set}	T _{fix}

<p>Status Function Action Set time Set date</p>	<p>Start Standby Program 1 Program 2 Program 3 Program 4 Program 5</p>			
Pump	Menu	End	T _{set}	T _{fix}

- **Weekplan** → **Arrange** takes you to the window shown on the left.
- Using the cursor keys , select the field, which is to be filled in.
- Open the input dialog of the field with : Select a time in the time fields and an action in the action field.
- In the example on the right, the thermostat is started on Monday at 7:30h, Program 4 is executed at 10:00h on Tuesday and the standby mode is switched in on Friday at 16:00h. Fields displaying ----- are passive.
- Confirm each field selection with or quit with without making changes.

The menu **Action** is used to define **what** is to be carried out:

- **Start** activates the thermostat from the standby mode.
- **Standby** activates the standby mode (refrigerating unit, heater and pump are switched off).
- **Program X** all actions of this program defined in the programmer are processed.

7.11 Control parameters

The control parameters are optimized ex-works for operation as a bath thermostat (with water as the bath medium) with internal control. The parameters are also preset for the operation of external containers with external control. Sometimes however, the operation of external containers requires adaptation. In addition, the thermal capacity and viscosity of the heat transfer liquid sometimes require adaptation.



- The intelligent menu guidance with the Master control element and Command remote control detects whether you have set the device (as described in Section 7.5.4), to internal or external control and only displays, the relevant dialog boxes in each case.
- Your Proline Kryomat automatically optimizes some control parameters. This automatic mechanism should only be deactivated and manually optimized in exceptional cases.

7.11.1 Internal control variable (integral measurement probe)

Only read further here, if you have no external temperature probe connected (and activated according to Section 7.5.4 as control variable).

Command

Control Parameters

Control para. sets

Tv manual/auto

Self Adaption

Correction limitation

Xp		6,0
Tn		30
Tv	(auto)	21
Td	(auto)	3,5

Pump
Menu
End
T_{set}
T_{fix}



– **Control Parameters**

– Open the device parameter menu via the soft key  **Menu** .

– With the cursor keys continue to → **Control** → **Control Parameters** → **Control Parameters** .

– The adjacent window appears.

– Change parameters marked with (auto) where necessary to manual input with **Tv manual/auto** .

– Select the parameters to be changed with  and confirm with  .

– Then in the following settings window, change the value and confirm with  .

7.11.1.1 Proven settings for control parameters and pump (integral measurement probe)

Instrument Type	Heat transfer liquid	Xp	Tn	Tv	Td	Pump level
		<i>x_p</i>	<i>t_n</i>	<i>t_v</i>	<i>t_d</i>	
RP 4090 CW	Water	9.0	60	42	6.3	8
RP 4090 CW	Ethanol	9.0	60	42	6.3	8
RP 4090 C	Water	9.0	60	42	6.3	8
RP 4090 C	Ethanol	9.0	60	42	6.3	8

Technical changes reserved!

7.11.2 External control variable (External measurement probe)





You only need to read further here if you have connected an external temperature probe or the actual temperature is read in from a module (and you have activated it as control variable according to Section 7.5.4).

Only modify the control parameters if you have knowledge of control techniques.

The control system for external actual values is implemented for improvement of the control behavior as a two-stage cascade controller. A "master controller" determines the "internal setpoint", from the temperature setpoint and the external temperature, passed to the slave controller. The control value of the slave controller controls the heating and cooling.

When a setpoint step change is specified, it may be that the optimum control would set a bath temperature, which might significantly exceed the temperature desired on the external vessel. There is a correction limitation, which specifies the maximum permissible deviation between the temperature on the external load and the heat transfer liquid temperature.

Command				
Control Parameters		Kpe	0,50	
Control para. sets		Tne	100	
Tv manual/auto		Tve (auto)	83	
Self Adaption		Tde (auto)	8,3	
Correction limitation		Xpf	4,0	
		Prop_E(a)	30	
Pump	Menu	End	T _{set}	T _{fix}

- **Control Parameters**
- Open the device parameter menu via the soft key  **Menu**.
- With the cursor keys continue to: **Control** → **Control Parameters** → **Control Parameters**.
- The adjacent window appears.
Parameter endings:
e = Master controller, f = Slave controller.
- Where applicable change parameters marked with (auto) to manual input with **Tv manual/auto**.
- Select the parameters to be changed with  and confirm with .
- Then change the value in the following settings window and confirm with .
- **Correction limitation** see introduction.

7.11.2.1 Steps for setting the control parameters for external control

1. Activate external control ⇒ 7.5.4.
2. Setting the slave controller:
 - 2.1. Set parameters to **auto**; Check for thermostat type and change when necessary (RP...) ⇒ 9.1.1.
 - Choose heat transfer liquid with low viscosity and high thermal capacity.
Ranking: water, ethanol, water-glycol, oil, Fluorinert®.
 - Set pump level as high as possible,
 - make bath circulation strong and fast,
 - choose hose length as short as possible, i.e. 2 x 1m,
 - choose hose cross section as large as possible, i.e. ½ inch,
 - throughput through the external load as large as possible.

2.2. Xpf setting:

- when oscillating with short period occur (i.e. 30 seconds) → Xpf lower, otherwise higher,
- in case of bad thermal coupling and large thermal mass → high (i.e. 2 – 5, or even higher),
- in case of good thermal coupling and small thermal mass → low (i.e. 0.2 – 0.7),
- when rapid temperature response is required simple internal control should be preferred. Otherwise select small Xpf (0.05 – 0.1).

3. Setting the master controller (PIDT1-controller):

- Start with setting Auto and proceed with Manual only when necessary.

3.1. Kpe setting:

- In case of oscillations with large period, i.e. 10 min) → Kpe higher, otherwise lower.

3.2. Tne/ Tve/ Tde setting:

- Start with high numbers (Tne = 70s – 200s; Tve = 50s – 150s).
- With lower numbers → faster approach, otherwise slower approach with lower oscillations.
- Tve: to reduce overshoot → Tve higher, otherwise lower.
- Tde (damping for Tve): in general approximately 10% of Tve.

4. Correction limitation (or outflow temperature limitation) ⇔ 7.11.2 and temperature limits (Til/Tih) ⇔ 7.6.2:

- Make settings in accordance with the boundary conditions. Examples:

Heat transfer liquid	Correction limitation	Til	Tih
Water	depending on the external vessel size and the heat transfer liquid	+2°C	+95°C
Ethanol		Minimum	+40°C

- Tools to watch the time behavior: Graph mode of the Command remote control, LAUDA Wintherm PC-program.

7.11.3 Internal and external control parameter sets

If a thermostat is used for a number of applications, which always leads to a change of the control parameters, these control parameters (up to 9 sets) can be saved in the thermostat and activated again as required.

Also saving is useful for finding the best control parameters; in this way external management of the control parameters can be avoided.

There are 9 sets (each for internal and external sets of control parameters) saved at the factory. In this menu the control parameters cannot be edited, they are only displayed.

- With **Activate** the currently valid control parameters are used.
- With **Upload actual** the actual ones are read in and saved (for later reuse).
- With **Default** the set of control parameters saved at the works is loaded again (in this case the control parameters set by the customer are lost).







Command

Control Parameters Control para. sets Tv manual/auto Self Adaption Correction limitation	Set 1 Set 2 Set 3 Set 4 Set 5 Set 6 Set 7 Set 8 Set 9
--	---

Pump	Menu	End	T _{set}	T _{fix}
------	------	-----	------------------	------------------

Status intern extern	Activate Upload actual Default
----------------------------	--------------------------------------

Pump	Menu	End	T _{set}	T _{fix}
------	------	-----	------------------	------------------

- **Control parameter sets**
- Open the device parameter menu via the soft key  **Menu**.
- With the cursor keys continue to:
 **Control Parameters** → **Control para. sets**.
- The adjacent window appears. Set 1 to Set 9.
- Select the desired set with  and confirm with .
- Select the desired set to be changed with  and confirm with .
- In the setting window (see left) the selected set is listed under **internal** or **external** in the display.
- Under **Status** the previously selected set: is activated, is read in and the set, which was saved at the factory, is restored.

Editing the control parameter sets

The change in the control parameters is explained in Section 7.11.1 / 7.11.2 (internal / external). Once the value has been changed and confirmed, the set number, e.g. **Set 3** and **Upload actual**, the new value is accepted into the control parameter set to be changed (Set 3) via the command **Control parameter sets**.

7.11.4 Self Adaption

The function Self Adaption can be used to detect automatically the optimal control parameters for internal or external control.

The Self Adaption can only be performed on a device with active cooling.



This function is available from software version 2.18 of Command. For thermostats with an older software version a software update is necessary.



The Self Adaption determines the parameters by a test run of the thermostat. In this case the thermostat and, if applicable, the external application must be ready for operation. (⇒ 6).

The Self Adaption will be performed with the actually set pump step. Best results can be achieved with high pump steps.

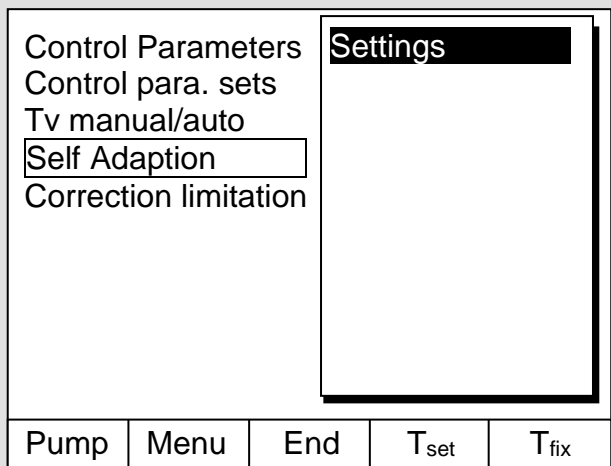
The test run must be performed at a passive system; this means that during the test run an exothermic or endothermic reaction mustn't take place.

The test run takes depending on the external application about 30 minutes to 3 hours. The bath temperature will oscillate in this time less than about ± 15 Kelvin around the set temperature. After the test run the detected control parameters will be taken over as control parameters automatically.

Command	Self Adaption
 <p>Control Parameters Control para. sets Tv manual/auto Self Adaption Correction limitation</p> <p>Pump Menu End T_{set} T_{fix}</p>	<ul style="list-style-type: none">– Open the device parameter menu via the soft key  Menu.– With the cursor keys continue to: → Control Parameters → Control Parameters → Self Adaption → Settings.– Confirm selection with .

<div style="border: 1px solid black; padding: 5px;"> <p>Status</p> <p>Setpoint</p> <p>Identification</p> <p>Actual Parameters</p> </div> <div style="border: 1px solid black; padding: 5px; margin-top: 5px;"> <p>Start</p> </div> <div style="display: flex; justify-content: space-between; margin-top: 5px;"> Pump Menu End T_{set} T_{fix} </div>	<ul style="list-style-type: none"> - The window shown adjacent appears. - With the menu Status the test run of the Self Adaption can be started. When the Self Adaption is finished, the test run will be terminated automatically. - As soon as start  is pressed, in the sofkey area the information Adaption on will be displayed followed by the actual status of the test run.
<div style="border: 1px solid black; padding: 5px;"> <p>Status</p> <p>Setpoint</p> <p>Identification</p> <p>Actual Parameters</p> </div> <div style="border: 1px solid black; padding: 5px; margin-top: 5px;"> <p>30,00°C</p> </div> <div style="display: flex; justify-content: space-between; margin-top: 5px;"> Pump Menu End T_{set} T_{fix} </div>	<ul style="list-style-type: none"> - With the menu Setpoint the set temperature for the test run can be set. The bath temperature will oscillate less than about ± 15 Kelvin around the set temperature. - Change the display in the adjacent window and accept with .
<div style="border: 1px solid black; padding: 5px;"> <p>Status</p> <p>Setpoint</p> <p>Identification</p> <p>Actual Parameters</p> </div> <div style="border: 1px solid black; padding: 5px; margin-top: 5px;"> <p>intern</p> <p>intern + extern</p> </div> <div style="display: flex; justify-content: space-between; margin-top: 5px;"> Pump Menu End T_{set} T_{fix} </div>	<ul style="list-style-type: none"> - With the menu Identification the optimal control parameters for internal control or for the internal control and the external control can be detected automatically. To detect the control parameters for the external application, a temperature probe must be connected to the thermostat.

Status Setpoint Identification Actual Parameters				
<div style="border: 2px solid black; padding: 5px; display: inline-block;"> Store in Set 9 </div>				
Pump	Menu	End	T _{set}	T _{fix}

- With the menu **Actual Parameters** the actual set control parameters can be stored in parameter set 9. After the test run the detected control parameters will be taken over as control parameters automatically. If the parameters found do not fulfil your expectations, the before set parameters can be restored (⇒ 7.11.3).

7.12 Alarms, Warnings and Errors



The SelfCheck Assistant of your Proline Kryomat monitors more than 50 device parameters and triggers alarms, warnings or errors as appropriate.



All warnings and alarms are shown on the Command remote control in plain text. Errors are shown in plain text on the Command remote control, also, in an error list.

Alarms: Alarms are safety relevant. Pump, heater and refrigerating unit will be shut off.

Warnings: Warnings normally are not safety relevant. The device continues to operate.

Errors: If an error occurs, the pump, heater and refrigerating unit switch off automatically. Switch of the unit at the rotary mains switch. If the error is always present after switching on the device, please give information to the LAUDA Service (⇒ 9.5).

Find cause of alarm or warning and rectify where necessary. Then press  on the Master keyboard in order to remove the alarm message. Warning messages can be removed either on the Master keyboard with  or on the Command board with .

Warnings may be ignored by pressing  or  on the Master keyboard or by activating the Screen Softkey on the Command remote control. Warnings will not be repeated periodically.

7.12.1 Overtemperature protection and checking



Risk of heat transfer liquid overheating due to incorrect entry of overtemperature switch-off point T_{max} .

Fire

- The overtemperature switch-off point must be below the flash point of the heat transfer liquid. Set the overtemperature switch-off point (T_{max}) to 5 K above the upper limit of the temperature range for your application.



The units are designed for operation with non-flammable and flammable liquids to DIN EN 61010-2-010.



– Setting the overtemperature cut-off: Recommended setting: 5 °C above desired bath temperature.

– **Caution!!** The overheat switch-off point T_{max} is controlled by a system functioning independently of the bath control. Setting of the nominal temperature, however, can be limited via the functions T_{ih} and T_{il} (⇒ 7.6.2) independently of T_{max} .

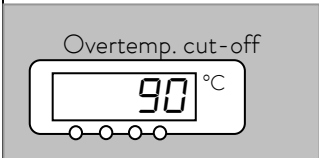

– The cut-off point is displayed in the LED display on pressing the key

Changing the overtemperature cut-off point:

– For safety, and to guard against unintentional adjustment, the key must be held pressed during all the following entries. Now, briefly press . The display flashes and the overtemperature cut-off can be set with the keys or .

– Quit the change mode by pressing for a few seconds or automatically after 5 seconds, while you keep pressed.

– This somewhat complicated procedure is intended to prevent unintentional adjustment.



- Set the overtemperature switch-off point T_{max} below the flash point of the heat transfer liquid.
- The setting range is restricted to 5 °C above the upper limit of the working temperature range (T_{ih} ⇒ 7.6.2).



– If the bath temperature rises above the overtemperature cut-off:

1. Alarm sounds as dual-tone signal.

2. for overtemperature appears in the display.

3. The red LED above the fault triangle flashes.

→ Heater switches off on both poles,

→ Pump and refrigerating unit are switched off electronically.

– Rectify cause of fault.

– Wait until the bath temperature has cooled below the cut-off point or set the cut-off point higher than the bath temperature. When is shown in the display:

– Unlock with the key.

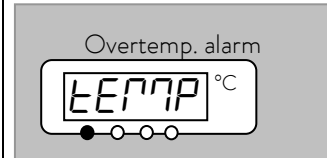

Unlocking is not possible on the Command remote control!











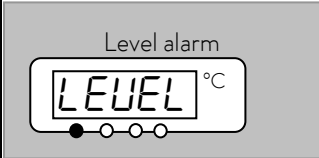

– Before longer periods of unsupervised operation, the **overtemperature protection should be checked**.
To do this:

– Slowly lower T_{max} , as described above.

→ Cut-off at the bath temperature should occur.

	<ul style="list-style-type: none"> – Step 1 – 2 (see above) must follow. – Set the overtemperature cut-off higher than the bath temperature again and wait until TEMP appears in the display. – Unlock with the  key. <p>Unlocking is not possible on the Command control element!</p>
Command	– Overtemperature alarm!
	– Overtemperature alarm! is shown in the display and signifies that <u>unlocking</u> is only possible on the <i>Master control panel</i> .

7.12.2 Low-level alarm and low-level checking

 	<ul style="list-style-type: none"> – If the liquid level falls so far that the heating element is no longer completely covered with liquid, an alarm is initiated:
	<ol style="list-style-type: none"> 1. The alarm sounds as a dual-tone signal. 2. Display for LEVEL (low level) is shown when the bath contains too little liquid. 3. The red LED  above the fault triangle  flashes. <ul style="list-style-type: none"> → Heater switches off on both poles, → Varioflex pump and refrigerating unit are switched off.
 	<ul style="list-style-type: none"> – Find the cause of the fault and, where necessary, top up for missing liquid (⇒ 6.2 and 6.3).
	<ul style="list-style-type: none"> – Press the Enter key. – Also, press this key if the unit has been switched off in the fault state.
	<ul style="list-style-type: none"> – Checking the safety system at regular intervals by lowering the bath level. To do this, fit a hose to the drain point and slowly run off the heat transfer liquid into a suitable container via the drain-point tap at the front. – Step 1 – 2 must follow.
	<ul style="list-style-type: none"> – With this test, the bath temperature must not be below 0 °C or above 50 °C, otherwise there is a risk of injury! – If irregularities arise during the checking of the safety devices, switch off the unit immediately and pull out the mains plug. – Have the equipment checked by LAUDA Service.
Command	– Low-level alarm!
	– Low-level alarm! is shown in the display and signifies that <u>unlocking is only possible</u> on the <i>Master control panel</i> .

7.12.3 High-level settings





Different reactions can be chosen when the level sensor detects the height of the heat transfer liquid level. Depending on the setup, heat transfer liquid or operation conditions, one of the following settings may be suitable:

Setting	Master settings	Command settings	Reaction and application recommendation
No warning	nHnon	none	Select only when no safety sensitive application. I.e. water as heat transfer liquid.
Warning	nHLUJ	Warning	Acoustic and optical warning as long as the level goes down. This is the factory setting.
Warning and heater off	nHLUJH	Warning + heater off	Warning and additional heater off as long as the level goes down. Recommended for flammable heat transfer liquids with much higher flash point and temperatures above 100 °C.
Alarm	nHLRA	Alarm	Alarm switches off the pump and the heater until the alarm is removed by  . Recommended for external loads and flammable liquids.

Command — **Over level handling**







Over level handling

none
Warning
Warn.+ Heater off
Alarm



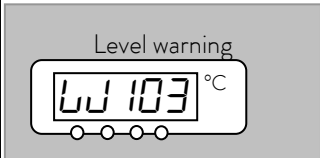
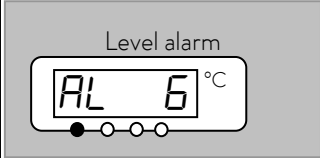



- Open the device parameter menu via the soft key  **Menu**.
- With the cursor keys continue to **Settings** → **Over level handling**.
- The shown window appears
- Select the preferred parameter with  or  and confirm with .
- See introduction for details.

Pump
Menu
End
T_{set}
T_{fix}

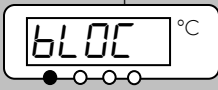







7.12.4 High-level warning or alarm

	<ul style="list-style-type: none"> – Acoustic warning signal sounds for 3 seconds when the liquid level rises so far that the uppermost switching point of the level sensor has been reached.
 	<ul style="list-style-type: none"> – Or in case the warning function as described in 7.12.3 was chosen: – The acoustic signal with dual-tone sounds. – Warning LWArn 103 (high level) appears when the bath contains too much liquid. – The LWArn flashes by turns with the numeral.
	<ul style="list-style-type: none"> – In case the alarm function as described in 7.12.3 was chosen: – The acoustic signal with dual-tone sounds. – The red LED  above the fault triangle  flashes. → Heater switches off on both poles, → Pump and refrigerating unit are switched off electronically.
	<ul style="list-style-type: none"> – Find the cause of the fault. Possible causes may be: <ol style="list-style-type: none"> 1. Volume expansion on heating. 2. Feed to an external vessel may be interrupted so that only return suction is possible. 3. Heat transfer liquid taking up moisture.
<p>Command</p>	<ul style="list-style-type: none"> – High-level warning/alarm
	<ul style="list-style-type: none"> – The display shows Warning. To release press Enter key Security 3 Level too high or Alarm AL 6: Level too high is shown in the display and signifies that unlocking is only possible on the Master control panel.

7.12.5 Pump-motor supervision: Overload or blockage

 <div style="border: 1px solid gray; padding: 5px; margin: 5px 0;"> <p style="text-align: center;">Pump alarm</p>  </div> <div style="display: flex; justify-content: space-around; align-items: center;">   </div> <div style="display: flex; justify-content: center; align-items: center; margin-top: 20px;">  </div>	<ul style="list-style-type: none"> - The SelfCheck Assistant monitors the Varioflex pump: 1. Alarm sounds as dual-tone signal for pump-motor overload or blockage. 2. Display of bLOC signals blockage. 3. The red LED  above the fault triangle  flashes. <ul style="list-style-type: none"> → Heater switches off on both poles, → Pump and refrigerating unit are switched off electronically. <ul style="list-style-type: none"> - Find the cause of the fault. Perhaps the viscosity of the heat transfer liquid is too high or the pump is blocked. - Press the Enter key. - Also press this key if the unit has been switched off in the fault state.
<p>Command</p>	<p>- Pump-motor alarm!</p>
	<p>- Pump-motor alarm is shown in the display and signifies that <u>unlocking is only possible on the Master control panel</u>.</p>

7.12.6 Pump-motor supervision: Dry running

 <div style="border: 1px solid gray; padding: 5px; margin: 5px 0;"> <p style="text-align: center;">Pump alarm</p>  </div> <div style="display: flex; justify-content: space-around; align-items: center;">   </div> <div style="display: flex; justify-content: space-between; align-items: center; margin-top: 20px;">  <div style="flex-grow: 1;"> <p>- The cause of the failure of the level measurement with the floatation sensor must be found and rectified. Perhaps foreign bodies in the bath block it.</p> </div> </div> <div style="display: flex; justify-content: center; align-items: center; margin-top: 20px;">  </div>	<ul style="list-style-type: none"> - The SelfCheck Assistant monitors the Varioflex pump: 1. Alarm sounds as dual-tone signal when the pump runs without liquid. This can only occur when the float level measurement has failed. 2. The display of PuLEU signals that the SelfCheck Assistant has detected a pump low level. 3. The red LED  above the fault triangle  flashes. <ul style="list-style-type: none"> → Heater switches off on both poles, → Pump and refrigerating unit are switched off electronically. <ul style="list-style-type: none"> - Press the Enter key. - Also press this key if the unit has been switched off in the fault state.
<p>Command</p>	<p>- Alarm! Low level (pump)</p>
	<p>- Alarm! Low level (pump) is shown in the display and signifies that <u>unlocking is only possible on the Master control panel</u>.</p>

7.12.7 Compressor Overtemp

Command	Error! Comp1 overtemp
	<ul style="list-style-type: none"> – Error! Comp1 overtemp is shown in the display. The cause may be a technical malfunction or an extremely situation in temperature control. Switch off the unit and wait min. 15 minutes to restart it again so that the compressor has time enough to cool down again. – This error may affect stage 1 (Error 68) or stage 2 (Error 69). – If the error is always present after switching on the device, please give information to the LAUDA Service (⇒ 9.5).

7.12.8 Three-phase current

Command	Error! Three-phase current
	<ul style="list-style-type: none"> – Error! Three-phase current is shown in the display, signed by number 70. The cause is the wrong direction of the current rotation field. It has to be clockwise! – Another reason may be the missing of one phase of the voltage supply.

7.12.9 Fault list „Alarms and Warnings“

Alarms

Message	Meaning
<i>PULLEU</i>	Pump too fast (low level)
<i>LEUEL</i>	Low level alarm in the level sensor
<i>TEPNP</i>	Overtemperature ($t > t_{max}$)
<i>BLOC</i>	Pump blocked (no rotation)
<i>CFR IL</i>	Command remote control connection interrupt
<i>AL 1</i>	Temperature signal of external Pt100 missing
<i>AL 2</i>	Temperature signal of analogue input missing
<i>AL 3</i>	Temperature signal of serial port missing
<i>AL 4</i>	Analogue module: Current input 1 interrupted
<i>AL 5</i>	Analogue module: Current input 2 interrupted
<i>AL 6</i>	Protection system: High bath level
<i>AL 7</i>	Error digital input
<i>AL 8</i>	Refill fail

Warnings in the “Master-Display”

Message	Meaning
<i>WJ 1</i>	Overflow of CAN receipt
<i>WJ 2</i>	Watchdog-Reset
<i>WJ 3</i>	til-limitation active
<i>WJ 4</i>	tih-limitation active
<i>WJ 5</i>	Heatsink temperature is superheated
<i>WJ 11</i>	Software version of protection system too old
<i>WJ 12</i>	Software version of operating system too old
<i>WJ 13</i>	Software version of heating system too old
<i>WJ 14</i>	Software version of analogue Interface too old
<i>WJ 15</i>	Software version of RS 232 too old
<i>WJ 16</i>	Software version of contact I/O module too old
<i>WJ 17</i>	Software version of valve 0 too old
<i>WJ 18</i>	Software version of valve 1 too old
<i>WJ 19</i>	Software version of valve 2 too old

Warnings in the “Safety system”

Message	Meaning
<i>WJ 101</i>	Overflow of CAN receipt
<i>WJ 102</i>	Watchdog-Reset
<i>WJ 103</i>	Close to bath overflow
<i>WJ 104</i>	Bath level is approaching switch off level or is out of optional range
<i>WJ 105</i>	Heater 1 break
<i>WJ 106</i>	Heater 2 break
<i>WJ 107</i>	Heater 3 break
<i>WJ 110</i>	Software version of control system too old
<i>WJ 112</i>	Software version of operating system too old
<i>WJ 113</i>	Software version of heating system too old
<i>WJ 114</i>	Software version of analogue interface too old
<i>WJ 115</i>	Software version of RS 232 too old
<i>WJ 116</i>	Software version of contact I/O module too old
<i>WJ 117</i>	Software version of valve 0 too old
<i>WJ 118</i>	Software version of valve 1 too old
<i>WJ 119</i>	Software version of valve 2 too old

LU 20	Software version of valve 3 too old
LU 21	Software version of pump 0 too old
LU 22	Software version of pump 1 too old
LU 23	Software version of pump 2 too old
LU 24	Software version of pump 3 too old

LU 120	Software version of valve 3 too old
LU 121	Software version of pump 0 too old
LU 122	Software version of pump 1 too old
LU 123	Software version of pump 2 too old
LU 124	Software version of pump 3 too old

Warnings in the "Command-Display"

Message	Meaning
LU201	Overflow of CAN receipt
LU202	Watchdog-Reset
LU203	RTC Voltage drop recognized: Battery failure
LU210	Software version of control system too old
LU211	Software version of protection system too old
LU213	Software version of heating system too old
LU214	Software version of analogue interface too old
LU215	Software version of RS 232 too old
LU216	Software version of contact I/O too old
LU217	Software version of valve 0 too old
LU218	Software version of valve 1 too old
LU219	Software version of valve 2 too old
LU220	Software version of valve 3 too old
LU221	Software version of pump 0 too old
LU222	Software version of pump 1 too old
LU223	Software version of pump 2 too old
LU224	Software version of pump 3 too old

Warnings from "Cooling system"

Message	Meaning
LU301	Overflow of CAN receipt
LU302	Watchdog-Reset
LU303	sm.stell_min still not determined → Adaption run necessary
LU304	Pressure switch 1 operated
LU305	Condenser dirty (→ cleaning)
LU310	Software version of control system too old
LU311	Software version of protection system too old
LU312	Software version of operation system
LU314	Software version of analogue interface too old
LU315	Software version of RS 232 too old
LU316	Software version of contact I/O too old
LU317	Software version of valve 0 too old
LU318	Software version of valve 1 too old
LU319	Software version of valve 2 too old
LU320	Software version of valve 3 too old
LU321	Software version of pump 0 too old
LU322	Software version of pump 1 too old
LU323	Software version of pump 2 too old
LU324	Software version of pump 3 too old

Warnings from "Analogue-Module"

Message	Meaning
LU401	Overflow of CAN receipt
LU402	Watchdog-Reset
LU410	Software version of control system too old
LU411	Software version of protection system too old
LU412	Software version of operation system
LU413	Software version of heating system too old

Warnings from "RS 232/485-Module"

Message	Meaning
LU501	Overflow of CAN receipt
LU502	Watchdog-Reset
LU510	Software version of control system too old
LU511	Software version of protection system too old
LU512	Software version of operation system
LU513	Software version of heating system too old

LJ4 15	Software version of RS 232 too old
LJ4 16	Software version of contact I/O too old
LJ4 17	Software version of valve 0 too old
LJ4 18	Software version of valve 1 too old
LJ4 19	Software version of valve 2 too old
LJ420	Software version of valve 3 too old
LJ42 1	Software version of pump 0 too old
LJ422	Software version of pump 1 too old
LJ423	Software version of pump 2 too old
LJ424	Software version of pump 3 too old

LJ5 14	Software version of analogue interface too old
LJ5 16	Software version of contact I/O too old
LJ5 17	Software version of valve 0 too old
LJ5 18	Software version of valve 1 too old
LJ5 19	Software version of valve 2 too old
LJ520	Software version of valve 3 too old
LJ52 1	Software version of pump 0 too old
LJ522	Software version of pump 1 too old
LJ523	Software version of pump 2 too old
LJ524	Software version of pump 3 too old

Warnings from "Contact I/O-Module"

Message	Meaning
LJ60 1	Overflow of CAN receipt
LJ602	Watchdog-Reset
LJ6 10	Software version of control system too old
LJ6 11	Software version of protection system too old
LJ6 12	Software version of operation system
LJ6 13	Software version of heating system too old
LJ6 14	Software version of analogue interface too old
LJ6 15	Software version of RS 232 too old
LJ6 17	Software version of valve 0 too old
LJ6 18	Software version of valve 1 too old
LJ6 19	Software version of valve 2 too old
LJ620	Software version of valve 3 too old
LJ62 1	Software version of pump 0 too old
LJ622	Software version of pump 1 too old
LJ623	Software version of pump 2 too old
LJ624	Software version of pump 3 too old

Warnings from "Solenoid valve" Code 7, 8, 9XX)

Message	Meaning
LJ70 1	Overflow of CAN receipt
LJ702	Watchdog-Reset
LJ7 10	Software version of control system too old
LJ7 11	Software version of protection system too old
LJ7 12	Software version of operation system
LJ7 13	Software version of heating system too old
LJ7 14	Software version of analogue interface too old
LJ7 15	Software version of RS 232 too old
LJ7 16	Software version of contact I/O too old
LJ72 1	Software version of pump 0 too old
LJ722	Software version of pump 1 too old
LJ723	Software version of pump 2 too old
LJ724	Software version of pump 3 too old

8 Interface modules

8.1 Installing of modules



Live parts when installing interfaces
<i>Electric shock</i>
<ul style="list-style-type: none"> • Disconnect the device from the mains power supply before installing interfaces. • The installation must only be performed by a specialist.



When switching off only on the master head, using the switch at the front or back, there is still voltage present on the unit or head.

Set the rotary switch on the front panel to "OFF = 0" and withdraw the mains plug.

The master can be supplemented with further interface modules, which are simply inserted at the back of the master control head into two module slots.

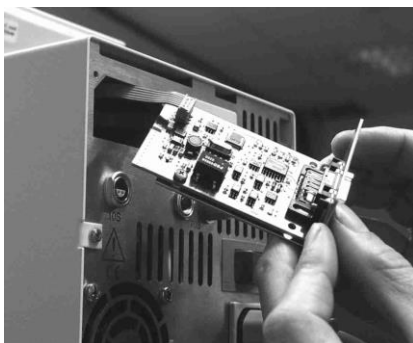

- Switch off the Kryomat at the rotary switch on the front panel and withdraw the mains plug.
- Touch the earthed bath cover of the Proline thermostat to discharge any electrostatic charge.
- Remove the module from its packaging.
- Insert a screwdriver into the lower recess of the module cavity and prise up the plastic cover. The cover can then be pulled off downwards.
- Pull out the plug of the bus connecting cable from the plastic cover.
- Plug on the bus connecting cable (red plug onto red socket).
- Insert the module and secure with the two crosshead screws.
- Connect the mains plug again and switch on the thermostat.



The plugs are protected against reverse polarity. The plugs have a ridge, which slides into a groove in the socket.

8.2 Menu structure for all modules

All existing menu points are illustrated. However, the Command remote control masks out menu points, which cannot be executed. Further information can be found in the following sections.

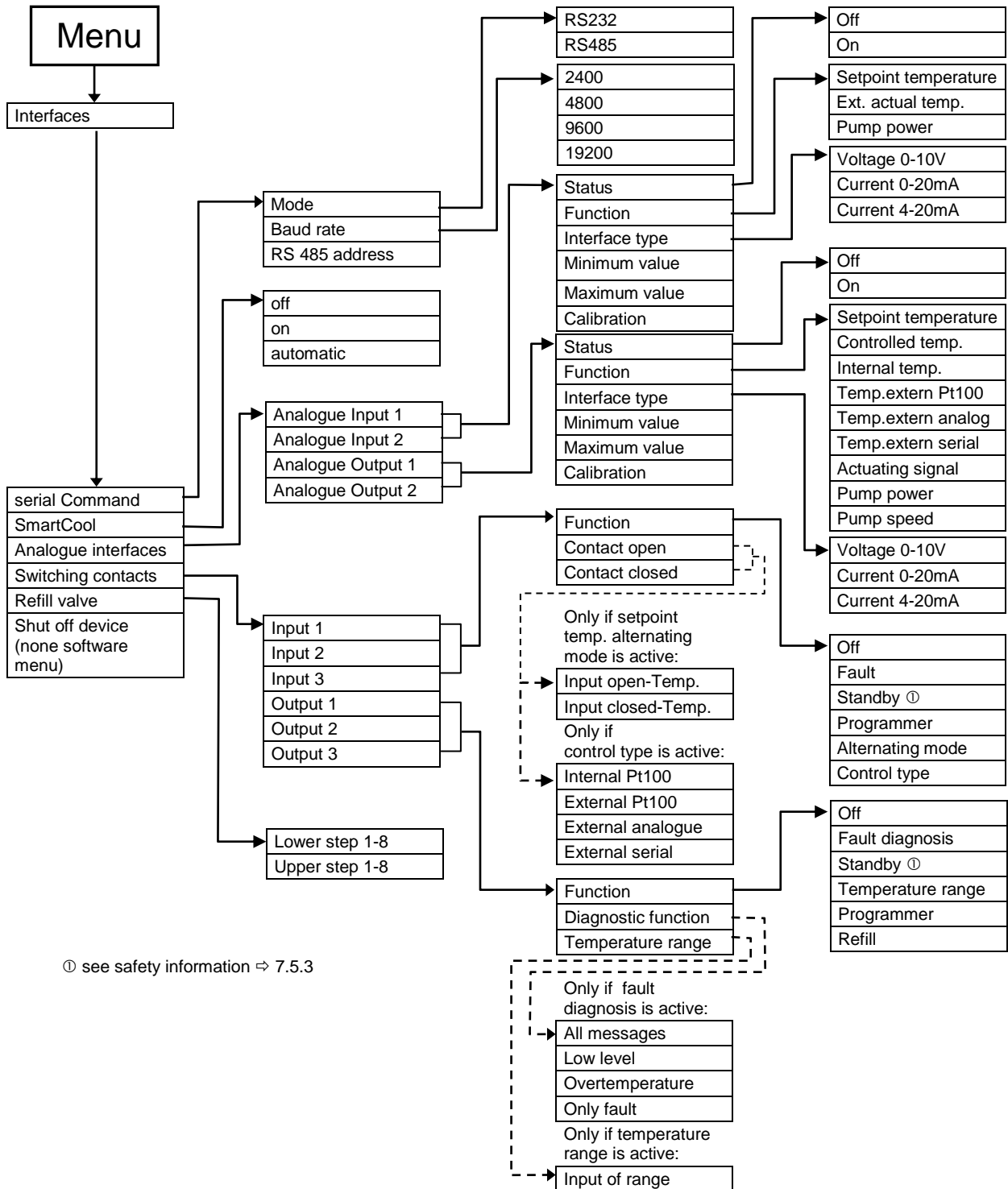

8.3 Serial interface RS 232/485

RS 232/485 Interface Module (order no. LRZ 913) with 9-pole SUB-D socket. Electrically isolated by optocoupler. With the LAUDA instruction set essentially compatible to the Ecoline and Integral Series. The RS 232 interface can be connected directly to the PC with a 1:1 through-contact cable (order no. EKS 037).

8.3.1 Connecting cables and interface test RS 232

Signal	Computer				Thermostat		Signal
	9-pin sub-D-socket		25-pin sub-D-socket		9-pin sub-D-socket		
	①	②	①	②	①	②	
R x D	2	2	3	3	2	2	T x D
T x D	3	3	2	2	3	3	R x D
DTR	4		20		4		DSR
Signal Ground	5	5	7	7	5	5	Signal Ground
DSR	6		6		6		DTR
RTS	7		4		7		CTS
CTS	8		5		8		RTS

① with hardware handshake: For connecting a thermostat to the PC use 1:1 cable and not a null-modem cable!

② without hardware handshake: the computer / PC must be set to the operating mode "without hardware handshake".



- Use screened connecting cable.
- Connect screen to connector case.
- The connections are galvanically isolated from the rest of the electronics.
- Any pins not in use must not be connected!

When a PC is connected up the RS 232 interface can easily be **tested** using the Microsoft Windows operating system. On Windows® 95/ 98/ NT/ XP with the "HyperTerminal" program.

"HyperTerminal" is no longer included in the later Windows operating systems.

- It is possible to communicate with the RS 232-interface using the LAUDA control and application software, Wintherm Plus (catalog number LDSM2002).
- Terminal programs are available on the Internet as freeware. These programs offer features similar to "HyperTerminal" (for example PuTTY). Search query "serial port terminal".

8.3.2 Protocol RS 232



- The interface operates with one stop bit, no parity bit and 8 data bits.
- Transfer rate either 2400, 4800, 9600 (factory setting) or 19200 baud as selected.
- The RS 232 interface can be operated with or without hardware handshake, (RTS/CTS).
- The command from the computer must be terminated with CR, CRLF, or LFCR.
- The response of the thermostat is always terminated with CRLF.
- After each command sent to the thermostat, it is necessary to wait for the reply before sending another command. This ensures that the sequencing of inquiries and answers is clear.

CR = Carriage Return (Hex: 0D)

LF = Line Feed (Hex: 0A)

Example: Transfer of setpoint 30.5 °C to the thermostat

Computer	Thermostat
"OUT_SP_00_30.5"CRLF	⇒
⇐	"OK"CRLF

8.3.3 Connecting cable RS 485

Thermostat	
9-pin sub-D-socket	
Pin	Data
1	Data A (-)
5	SG (Signal Ground) optional
6	Data B (+)



- Use screened connecting cables.
- Connect screen to connector case.
- The connections are galvanically isolated from the rest of the electronics.
- Any pins not in use must not be connected!

An **RS 485 bus** always requires bus termination in the form of a termination network, which ensures a defined rest status in the high-resistance phases of bus operation. The bus termination is as follows:

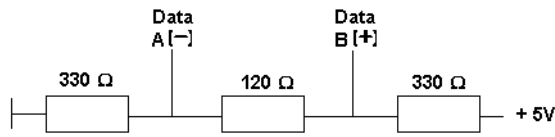

This termination network is usually incorporated on the PC plug-in card (RS 485).

8.3.4 Protocol RS 485



- The interface operates with one stop bit, no parity bit and 8 data bits.
- Transfer rate either 2400, 4800, 9600 (Factory setting) or 19200 baud as selected.
- The RS 485 commands are always preceded by the device address. There is provision for 127 addresses. The address must always have three digits. (A000...to A127...).
- The command from the computer must be terminated with CR.
- The response of the thermostat is always terminated with CR.

CR = Carriage Return (Hex: 0D)

Example: Transfer of setpoint 30.5 °C to the thermostat with address 15.

Computer	Thermostat
"A015_OUT_SP_00_30.5"CR	⇒
⇐	"A015_OK"CR

8.3.5 Write commands (Data commands to the thermostat)

Command	Explanation
OUT_PV_05_XXX.XX	External temperature to be set through the interface.
OUT_SP_00_XXX.XX	Setpoint transfer with up to 3 places before the decimal point and up to 2 places behind.
OUT_SP_01_XXX	Pump output step 1 to 8.
OUT_SP_02_XXX	Operation mode cooling (0 = OFF / 1 = ON / 2 = AUTOMATIC).
OUT_SP_04_XXX.X	TiH outflow temperature high limit.
OUT_SP_05_XXX.X	TiL outflow temperature low limit.
OUT_PAR_00_XXX	Setting of control parameter Xp.
OUT_PAR_01_XXX	Setting of control parameter Tn (5 – 180s; 181 = Off).
OUT_PAR_02_XXX	Setting of control parameter Tv.
OUT_PAR_03_XXX	Setting of control parameter Td.
OUT_PAR_04_XXX	Setting of control parameter KpE.
OUT_PAR_05_XXX	Setting of control parameter TnE (5 – 979 s; 980 = Off).
OUT_PAR_06_XXX	Setting of control parameter TvE (0 = OFF).
OUT_PAR_07_XXX	Setting of control parameter TdE.
OUT_PAR_09_XXX.X	Setting of the max. outflow temperature limit.
OUT_PAR_10_XXX	Setting of control parameter XpF.
OUT_PAR_14_XXX.X	Setting of the setpoint offset.
OUT_PAR_15_XXX	Setting of the control parameter PropE.

Command	Explanation
OUT_MODE_00_X	Keyboard Master: 0 = free / 1 = locked (corresponds to "KEY").
OUT_MODE_01_X	Control: 0 = internal / 1 = external Pt100 / 2 = external analogue / 3 = external serial / 5 = external Ethernet / 6 = external EtherCAT. Note: With some temperature control devices this command can only be carried out if the command OUT_PV_05_XXX.XX has been sent by the interface. Also notice that the command OUT_PV_05_XXX.XX must be cyclically transmitted by the selected interface.
OUT_MODE_03_X	Keyboard Command remote control: 0 = free / 1 = locked.
OUT_MODE_04_X	Setpoint offset source: 0 = normal / 1 = external Pt / 2 = external analogue / 3 = external serial. Note: With some temperature control devices this command can only be carried out if the command OUT_PV_05_XXX.XX has been sent by the interface. Also notice that the command OUT_PV_05_XXX.XX must be cyclically transmitted by the selected interface.
START	Switches the unit on (after Standby). See safety information (⇒ 7.5.3).
STOP	Switches the device into Standby (pump, heater, cooling unit OFF).
RMP_SELECT_X	Selection of the program (1 – 5) to which the further instructions apply. When the unit is switched on, program 5 is selected automatically.
RMP_START	Start the programmer.
RMP_PAUSE	Hold (pause) the programmer.
RMP_CONT	Restart the programmer after pause.
RMP_STOP	Terminate the program.
RMP_RESET	Delete the program (all Segments).
RMP_OUT_00_XXX.XX_XXXXX_XXX.XX_X	Set a programmer segment (temperature, time, tolerance and pump level). A segment is added and appropriate values are applied to it.
RMP_OUT_02_XXX	Number of times the program runs: 0 = unlimited / 1 – 250.



- For ”_“ use also ” ” (blank character).
- Response from thermostat ”OK“ or in case of error ”ERR_X“ (RS 485 interface e.g. ”A015_OK“ or in case of error ”A015_ERR_X“.).
- The command from the computer must be terminated with CR, CRLF, or LFCR.
- The response of the thermostat is always terminated with CRLF.
- After each command sent to the thermostat, it is necessary to wait for the reply before sending another command. This ensures that the sequencing of inquiries and answers is clear.

CR = Carriage Return (Hex: 0D)

LF = Line Feed (Hex: 0A)

Permitted data formats:

-XXX.XX	-XXX.X	-XXX.	-XXX	XXX.XX	XXX.X	XXX.	XXX
-XX.XX	-XX.X	-XX.	-XX	XX.XX	XX.X	XX.	XX
-X.XX	-X.X	-X.	-X	X.XX	X.X	X.	X
-.XX	-.X	.XX	.X				

8.3.6 Read commands (Data requested from the thermostat)

Command	Explanation
IN_PV_00	Read bath temperature (outflow temperature).
IN_PV_01	Indication of the controlled temperature (internal / external Pt / external Analogue / external serial).
IN_PV_03	Read external temperature TE (Pt100).
IN_PV_04	Read external temperature TE (Analogue input).
IN_PV_05	Read bath level.
IN_PV_10	Read bath temperature (outflow temperature) in 0.001 °C.
IN_PV_13	Read external temperature TE (Pt100) in 0.001 °C.
IN_SP_00	Read temperature setpoint.
IN_SP_01	Read current pump power level.
IN_SP_02	Read cooling operation mode (0 = OFF / 1 = ON / 2 = AUTOMATIC).
IN_SP_03	Read current overtemperature switch-off point.
IN_SP_04	Read current outflow temperature limit TiH.
IN_SP_05	Read current outflow temperature limit TiL.
IN_PAR_00	Read control parameter Xp.
IN_PAR_01	Read control parameter Tn (181 = OFF).
IN_PAR_02	Read control parameter Tv.
IN_PAR_03	Read control parameter Td.
IN_PAR_04	Read control parameter KpE.
IN_PAR_05	Read control parameter TnE (980 = OFF).
IN_PAR_06	Read control parameter TvE (0 = OFF).
IN_PAR_07	Read control parameter TdE.
IN_PAR_09	Read value of correction limitation
IN_PAR_10	Read control parameter XpF.
IN_PAR_14	Interrogation of the setpoint offset.
IN_PAR_15	Read control parameter PropE.
IN_DI_01	State of contact input 1: 0 = open/ 1 = closed.
IN_DI_02	State of contact input 2: 0 = open/ 1 = closed.
IN_DI_03	State of contact input 3: 0 = open/ 1 = closed.
IN_DO_01	State of Contact output 1: 0 = make-contact open/ 1 = make-contact closed.
IN_DO_02	State of Contact output 2: 0 = make-contact open/ 1 = make-contact closed.
IN_DO_03	State of Contact output 3: 0 = make-contact open/ 1 = make-contact closed.
IN_MODE_00	Keyboard Master: 0 = free / 1 = locked. .
IN_MODE_01	Control: 0 = internal / 1 = external Pt100 / 2 = external Analogue / 3 = external Serial / 5 = external Ethernet / 6 = external EtherCAT..
IN_MODE_02	Standby operation: 0 = Device ON / 1 = Device OFF.
IN_MODE_03	Keyboard Command remote control: 0 = free / 1 = locked.
IN_MODE_04	Setpoint offset source: 0=normal / 1=external Pt / 2=external analogue / 3=external serial.
TYPE	Read equipment type (response e.g. "RP 3090").
VERSION_R	Read software type of control system.
VERSION_S	Read software type of protection system.

Command	Explanation
VERSION_B	Read software type of Command.
VERSION_T	Read software type of cooling system.
VERSION_A	Read software type of analogue module.
VERSION_V	Read software type of RS 232/485 module.
VERSION_D	Read software type of digital module.
VERSION_M_0	Read software type of solenoid valve (cooling water).
VERSION_M_1	Read software type of solenoid valve (automatic refill).
VERSION_M_3	Read software type of solenoid valve (shut-off valve 1)
VERSION_M_4	Read software type of solenoid valve (shut off valve 2).
VERSION_M_5	Read software type of high temperature cooler.
STATUS	Read equipment status 0 = OK, -1 = error.
STAT	Read error diagnosis response: XXXXXXXX → X = 0 no error, X = 1 error. 1. char = error. 2. char = Alarm. 3. char = Warning. 4. char = over temperature. 5. char = low-level error. 6. char = high-level error (at adjustment alarm). 7. char = no external control variable.
RMP_IN_00_XXX	Read a program segment XXX (response: e.g. 030.00_010.00_005.00_001.00 → set point temperature 30.00 °C, time = 10 min, tolerance = 5.00 °C, pump level = 1).
RMP_IN_01	Read the current segment number.
RMP_IN_02	Read the set number of program runs.
RMP_IN_03	Read the current program run.
RMP_IN_04	Read the program to which further instructions apply.
RMP_IN_05	Read which program is currently running (0 = none).
LOG_IN_00_XXXX	Query a measuring point XXXX from data logger (Reply: e.g. 020.00_021.23_030.50 => set point temperature = 20.00 °C, bath temperature = 21.23 °C, external temperature = 30.5 °C).
LOG_IN_01	Read all measuring points from data logger As a difference to the command "LOG_IN_00", a tabulator is used here as separator instead of ',' . The measuring points are separated by CR and LF. The end is marked by CR LF CR LF.
LOG_IN_02	Read the start time from data logger (Reply: e.g. 20_14_12_20 → day 20, time 14:12:20).
LOG_IN_03	Read the acquisition interval from the data logger (Reply in seconds).



- For ”_“ use also ” ” (blank character).
- The equipment response is always in the fixed decimal format ”XXX.XX“ or for negative values ”-XXX.XX“ or ”ERR_X“. (RS 485 interface e.g.. ”A015_XXX.XX“ or ”A015_-XXX.XX“ or ”A015_ERR_X“).
- The command from the computer must be terminated with CR, CRLF, or LF.
- The response of the thermostat is always terminated with CRLF.
- After each command sent to the thermostat, it is necessary to wait for the reply before sending another command. This ensures that the sequencing of inquiries and answers is clear.

CR = Carriage Return (Hex: 0D)

LF = Line Feed (Hex: 0A)

8.3.7 Error messages

Message	Explanation
ERR_2	Wrong input (e.g. buffer overflow)
ERR_3	Wrong command
ERR_5	Syntax error in value
ERR_6	Illegal value
ERR_8	Module (ext. temperature) not available
ERR_30	Programmer, all segments occupied.
ERR_31	Set point not possible, analogue set point input ON.
ERR_32	TiH <= TiL.
ERR_33	No external sensor
ERR_34	Analogue value not available
ERR_35	Auto is selected
ERR_36	No set point input possible. Programmer is running or is pausing.
ERR_37	No start from programmer possible, analogue setpoint input is switched on.

8.3.8 Driver software for LABVIEW®

An individual, easy-to-use control and automation software for operating the PROLINE device can be programmed with the aid of the National Instruments program development tool LABVIEW®

(<http://sine.ni.com/apps/we/nioc.vp?cid=1381&lang=US>).

In order to make program operation possible on the RS 232/485 interface, LAUDA provides drivers specially designed for LABVIEW® which can be downloaded free of charge under <https://www.lauda.de/en/>.

8.4 Analogue module

The analogue module (order no. LRZ 912) has 2 inputs and 2 outputs, which are brought out on a 6-pole socket to Namur Recommendation (NE28). The inputs and outputs can be set independently as 0 – 20 mA, 4 – 20 mA or 0 – 10 V interface. Various functions can be selected for the inputs and outputs. Accordingly, the signal on the input is interpreted differently and different information is output via the output connection.

In addition the interfaces can be scaled freely according to the set function.

For measuring transducer is 20 V DC available.

The following values can be specified via the inputs:

- Setpoint temperature with function: $\overline{TT} \text{ } \underline{tS}$ or Set temperature.
- External actual temperature with function: $\overline{MN} \text{ } \underline{tE}$ or ext. actual temperature.
- Pump power with function: \overline{PP} or Pump power.

The following values can be specified via the outputs:

- Setpoint temperature with function: Master: $\overline{TT} \text{ } \underline{tS}$ or Command: Set temperature.
- The temperature source with which active control occurs: $\overline{TT} \text{ } \underline{tE}$ Controlled temp.
- Actual temperature (bath temperature): $\overline{TT} \text{ } \underline{tI}$ or Internal Temp.
- External actual temperature from Pt100: $\overline{TT} \text{ } \underline{tEP}$ or Temp.external Pt100.
- External actual temperature from analogue input: $\overline{TT} \text{ } \underline{tEA}$ or Temp.external analogue.
- External actual temperature from the serial interface: $\overline{TT} \text{ } \underline{tES}$ or Temp.external serial.
- Actuating signal: $\overline{TT} \text{ } \underline{y}$ or Actuating signal.
- Pump power: \overline{PP} or Pump power.
- Pump speed: $\overline{TT} \text{ } \underline{tEN}$ or Pump speed.

In addition the interfaces can be scaled freely with $L = 0 / H 10=0$ in % or minimal value / maximal value according to the set function.

for example: 4 mA corresponds to 0 °C and 20 mA corresponds to 100 °C.

- Accuracy of the inputs and outputs after calibration better than 0.1% F.S.
- | | |
|--------------------|----------------------------|
| - Inputs, current | Input resistance < 100 Ohm |
| - Inputs, voltage | Input resistance > 50 kOhm |
| - Outputs, current | Burden < 400 Ohm |
| - Outputs, voltage | Load > 10 kOhm |



Connection of the analogue inputs and outputs

A 6-pole round connector with screw locking and contact arrangement according to DIN EN 60130-9 or IEC 130-9 is needed.

A suitable coupling plug can be obtained under order no. EQS 057.

View of the socket (front) or solder side of plug:

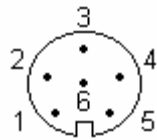

Socket 74S (from May 2010 onwards)

Pin 1	Output 1
Pin 2	Output 2
Pin 3	0 V reference potential
Pin 4	Input 1
Pin 5	+20 V (max. 0.1 A)
Pin 6	Input 2



Use shielded lines. Connect shielding with connector housing!

8.5 Contact module

8.5.1 Contact module LRZ 915 with three inputs and three outputs

Contact module Cat. no. LRZ 915) on 15 pole SUB-D socket. With three relay contact outputs (changeover, max. 30 V / 0.2 A) and three binary inputs for control via external voltage-free contacts.

The following functions are made available by the inputs:

- Set fault with function: Master: *F ALA* or Command: **Fault**.
- Set Stand by with function: *F Stb* or **Stand by**.
- Control programmer (Input 1 activates programmer 1, input 2 activates programmer 2 etc. At the first “close” the programmer gets starting, “open” removes it in “pause”. The next “close” initiate “continue”) with function: *F PrB* or **Programmer**.
- Control alternating mode (the switching state contact “open” or “closed” allot to two different setpoint temperatures): *F tZC* or **alternating mode**.
- Controller mode (the switching state input “open” or “closed” can allotted to two different control temperature sources. E. g. internal ↔ external control): *F Cn* or **type of control**.

The following functions are made available by the outputs:

- Signal various fault states: *F d iA* or **fault diagnosis**.
- Signaling standby: *F Stb* or **Standby**.
- Providing status of the window discriminators (inside ↔ outside): *F Lu i* or **temperature range**.
- Providing the programmer status: *F PrB* or **Programmer**.
- Signaling refill of heat transfer liquid: *F F iL* or **Refill**.

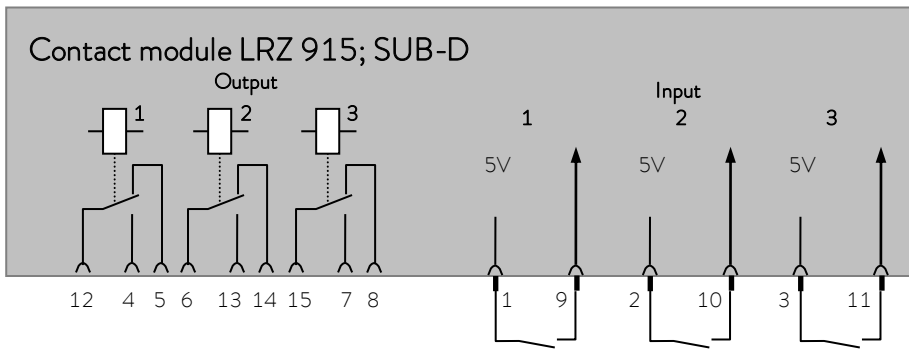

Contact inputs and outputs

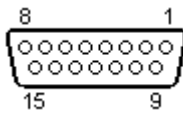

- View of the socket from the plug side or of the plug on the solder side.
- A suitable 15-pole Sub-D plug can be obtained together with a suitable housing:
Order no. EQM 030 and plug housing order no. EQG 017.

8.5.2 Namur-Contact module LRZ 914 with only one input and one output

Contact module (Cat. no. LRZ 914) with connector to NAMUR NE28. Functionality as LRZ 915, but only one output and one input on each of two DIN sockets.

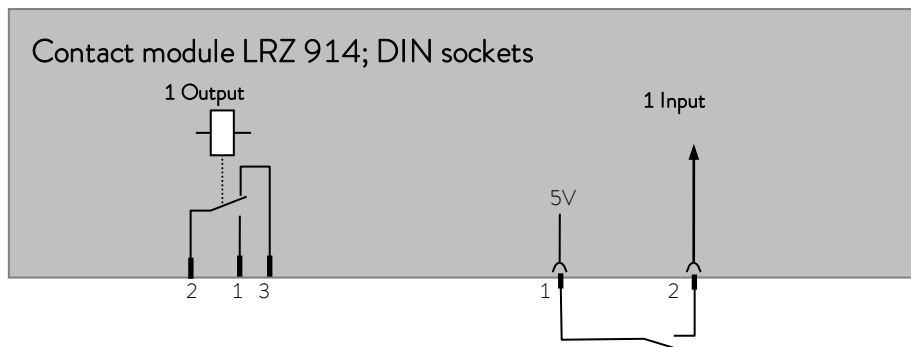

Contact inputs and outputs:

Output	Input
<ul style="list-style-type: none"> - View on flange plug (Front) or solder side coupler socket. - Max. 30 V; 0.2 A. Coupler socket Catalogue number EQD 047.	<ul style="list-style-type: none"> - View on flange plug (Front) or solder side coupler socket. - Signal circa 5 V, 10 mA. Do not use pin 3! Coupling plug Catalogue number EQS 048.
	1 = n.o. (make) 2 = common, 3 = n.c. (break)



- Use shielded lines. Connect shielding with connector housing. Cover unused plug connections with protecting caps!

9 Maintenance

9.1 Device status

The thermostat can be conveniently checked with the Command remote control.

9.1.1 Interrogating the device type

→ Settings → Device status → Device type

9.1.2 Software version

→ Settings → Device status → Software version.

The versions of the control system (Control), safety system (Safety), Command remote control (Command), cooling system (Cool) and, where applicable, other connected modules are displayed.

9.1.3 Serial numbers

→ Settings → Device status → Serial numbers.

The serial number of the Master (Master), Command remote control (Command), cooling system (Cool) and other connected modules are displayed.

9.1.4 Device data

Command		- Device data	
T ext Pt	25.70	T int	-8
T ext analog	---.---	Mains U(%)	100.74
T ext serial	---.---	Mains frequ.	50
T cont. head	39.80	Level	4
T heatsink	51.68	Low voltage	27.90
Pump pow.	44.90	5V supply	5.00
Pump rpm	5460	Fan voltage	7.0
Pumpe cur.	1.68	Cur. cons.	2.84
Pump	Menu	End	T _{set} T _{fix}

→ Settings → Device status → Device data → Display

- Text shows various actual temperatures in °C from ext. Pt100 and the modules.
- T cont. head and T heatsink are temperatures of electronics in the Master in °C.
- Pump power in Watts, speed in rpm, current in ampere (A).
- T_{int} indicates the current internal bath temperature in °C.
- Mains voltage in percentage (%) of nominal and frequency in hertz (Hz).
- Level indicates the liquid level in the internal bath.
- Voltage of power transformer, 5V supply and fan voltage in Volt.
- Cur. cons.: Mains current consumption in Ampere.

9.1.5 Fault memory

For the analysis and localization of faults the Command version includes a fault memory in which up to 45 fault and alarm messages are saved.

Command					
No.	Source	Code	Type	Date	Time
10	Safety	2	Alarm	-----	-----
9	Safety	4	Warn.	28.08.03	15:32:02
8	Contro.	32	Error	17.07.03	10.:52:02
7	Contro.	3	Warn.	06.06.03	11:15:11
6	Contro.	9	Alarm	05.06.03	08:45:01
5	Contro.	3	Alarm	01.06.03	17:58:22
4	Contro.	4	Warn.	28.05.03	20:01:22
3	Contro.	5	Warn.	27.05.03	07:58:00
Low level					
Pump	Menu	End	T _{set}	T _{fix}	

– **Error store**

→ **Settings** → **Device status** → **Error store** → **Display** :

- The last message is at the top.
- Each message line can be marked with the cursor keys. The message appears in plain text in the footer.
- Under “Source”, the CAN node is displayed which signaled the fault.
- Code is the number, which in the Master is shown in the display until the cause has been rectified.
- Type: Alarm, Warning or Fault (Error).

9.2 Cleaning

9.2.1 Cleaning the surface of the device



Live parts in contact with cleaning agents
<i>Electric shock hazard</i>
<ul style="list-style-type: none"> • Disconnect the device from the mains before cleaning.

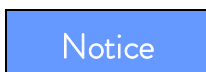

Live parts in contact with cleaning agents
<i>Property damage</i>
<ul style="list-style-type: none"> • Disconnect the device from the mains before cleaning. • Water and other liquids must not enter the control head.

Cleaning can be carried out with water to which a few drops of surfactant (washing-up liquid) have been added and using a damp cloth.



Carry out appropriate decontamination if hazardous material is spilt on or in the equipment.

The cleaning or decontamination method is determined by the user's specialist knowledge. In case of doubt, contact the manufacturer.

9.2.2 Draining the water-cooled condenser



Important: With the risk of frost (e.g. transport in winter), drain the condenser on water-cooled devices.

Remove the water hose on the water tap. Then open the solenoid valve for the water as described below. Blow compressed air in the water return hose Continue until all water has flowed out of the device.

Command					Start unfill condenser																																								
<table border="1"> <tr> <td>Pump</td> <td colspan="4">Pump Level</td> </tr> <tr> <td>Settings</td> <td colspan="4">Ext.Pump</td> </tr> <tr> <td>Graph</td> <td colspan="4">Start unfill conden</td> </tr> <tr> <td>Clock</td> <td colspan="4"></td> </tr> <tr> <td>Programmer</td> <td colspan="4"></td> </tr> <tr> <td>Interfaces</td> <td colspan="4"></td> </tr> <tr> <td>Control</td> <td colspan="4"></td> </tr> <tr> <td>Limits</td> <td colspan="4"></td> </tr> </table>					Pump	Pump Level				Settings	Ext.Pump				Graph	Start unfill conden				Clock					Programmer					Interfaces					Control					Limits					<ul style="list-style-type: none"> – Open the device parameter menu via the soft key Menu . – Change from Pump → Start unfill conden. using . – Use to open the solenoid valve for the water. The display changes automatically to the overview window. – To close the valve again selects this menu again. The item is called now End unfill conden. .
Pump	Pump Level																																												
Settings	Ext.Pump																																												
Graph	Start unfill conden																																												
Clock																																													
Programmer																																													
Interfaces																																													
Control																																													
Limits																																													
Pump	Menu	End	T _{set}	T _{fix}																																									

9.3 Servicing, cleaning, repair and disposal information



Live parts during troubleshooting
<i>Electric shock hazard</i>
<ul style="list-style-type: none"> • Disconnect the device from the mains before the repair (e.g. when changing components). • Have the repair carried out only by a specialist.



Rotating / live parts when removing the ventilator fan
<i>Cuts, crushing, electric shock hazard</i>
<ul style="list-style-type: none"> • Disconnect the device from the mains before the repair. • Have the repair carried out only by a specialist.



Uncontrolled start-up of the pump when jamming released
<i>Crushing, electric shock hazard</i>
<ul style="list-style-type: none">• Disconnect the device from the mains power supply before the repair.• Have the repair carried out only by a specialist.



Contact with hot or cold device parts, heat transfer liquid or accessories (hoses)
<i>Burns, scalds, frostbite</i>
<ul style="list-style-type: none">• Allow device parts, accessories and heat transfer liquid to reach room temperature before touching them.• Have repairs carried out only by a specialist.

9.3.1 Servicing

LAUDA Thermostats largely require no service. If the heat transfer liquid becomes contaminated, it should be replaced (⇒ 6.2).



- At the back of the Master head a main fuse switch  is located which interrupts the mains connection when an overload occurs. It is then in the "O" position and can be set in the "-" position again.
- If the fuse trips again, Service must locate the cause.
- Additionally, a safety fuse, which protects the low voltages, is situated on the mains board. If a fuse fails (→ mains lamp does not light) only replace with a fuse with the specified data (one x T (= slow-blow) 10 A, size 5 x 20 → the Fuse is located in the unit as shown below).

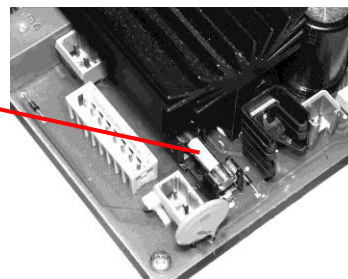
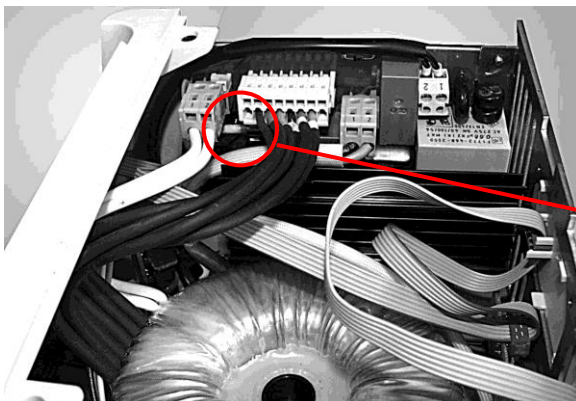

UL 533

9.3.2 Service intervals

System part	Frequency	Comment
	Each time of putting into operation and then	
Complete device		
External condition of the device	Monthly	
Heat transfer liquid		
Analysis of the heat transfer liquid	Half-yearly (and as required)	(⇒ 9.3.3)
Heat transfer system		
Sealing	Daily	External visual inspection
External hoses		
Material fatigue	Monthly	External visual inspection
Cooling unit		
Condenser cleaning	Monthly	(⇒ 9.3.4)
Electronics		
Over temperature protection	Quarterly	(⇒ 7.12.1)
Low level alarm/ warning	Quarterly	(⇒ 7.12.2)

9.3.3 Testing the heat transfer liquid



Contact with hot / cold heat transfer liquid
<i>Scalds, frostbite</i>
<ul style="list-style-type: none"> Bring the heat transfer liquid to room temperature for analysis.

If required, the heat transfer liquid should be checked for fitness for use (e.g. when changing the method of operation), or at least half-yearly. Further use of the heat transfer liquid is only permissible if the inspection indicates this.

The test of the heat transfer liquid should take place according to DIN 51529; Testing of mineral oils and related products - Testing and evaluation of used heat transfer fluids.

Source: VDI 3033; DIN 51529.

9.3.4 Cleaning the condenser

9.3.4.1 Air-cooled condenser



Contact with sharp slats on the condenser during cleaning
<i>Cutting</i>
<ul style="list-style-type: none">• Clean the condenser using suitable resources such as a hand brush or compressed air.

The SmartCool System refrigerating machine operates largely without servicing. So that the full cooling power is available, the heat exchanger (condenser) should be cleaned of dust at intervals of one month or longer depending on the operating period and dust level in the ambient air.

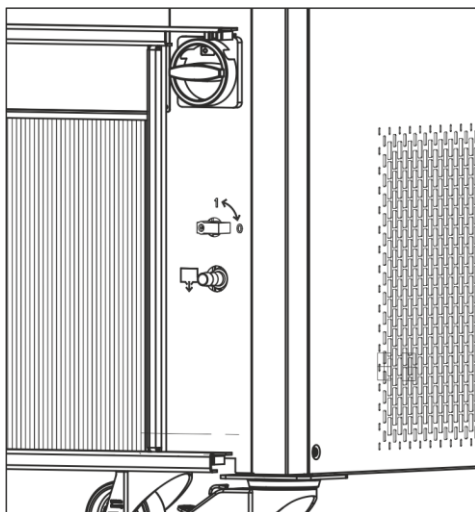

To do this, open the front grille, brush off the condenser and, where necessary, blow over with compressed air.

Extreme contamination is detected by the Proline SelfCheck Assistant, which then issues a warning.

9.3.4.2 Water-cooled condenser

9.3.4.2.1 Cleaning the dirt trap

At regular intervals of one month or longer, the dirt trap must be cleaned, depending on the degree of soiling.

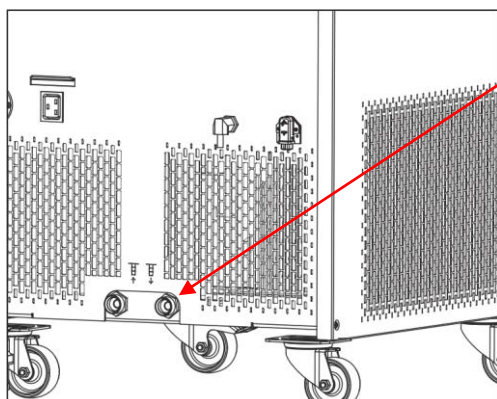

Take off the water feed hose on the device and remove the filter. Clean the filter and insert it again into the cooling water feed.

9.3.4.2.2 Decalcifying the water cooling circuit

At regular intervals of 3 months or longer, the water-cooled condenser must be decalcified or cleaned. This depends on the hardness of the cooling water and the degree of soiling. Drain according to (⇒ 9.2.2).

Required equipment:

- Two containers of approx. 10 to 20 liters volume.
- Use a suitable pump (drum pump) or a hose with funnel. Place the funnel as high as possible so that the device can fill quickly.
- Fit connecting hoses between container, pump, cooling water inlet and between cooling water outlet and back to container.

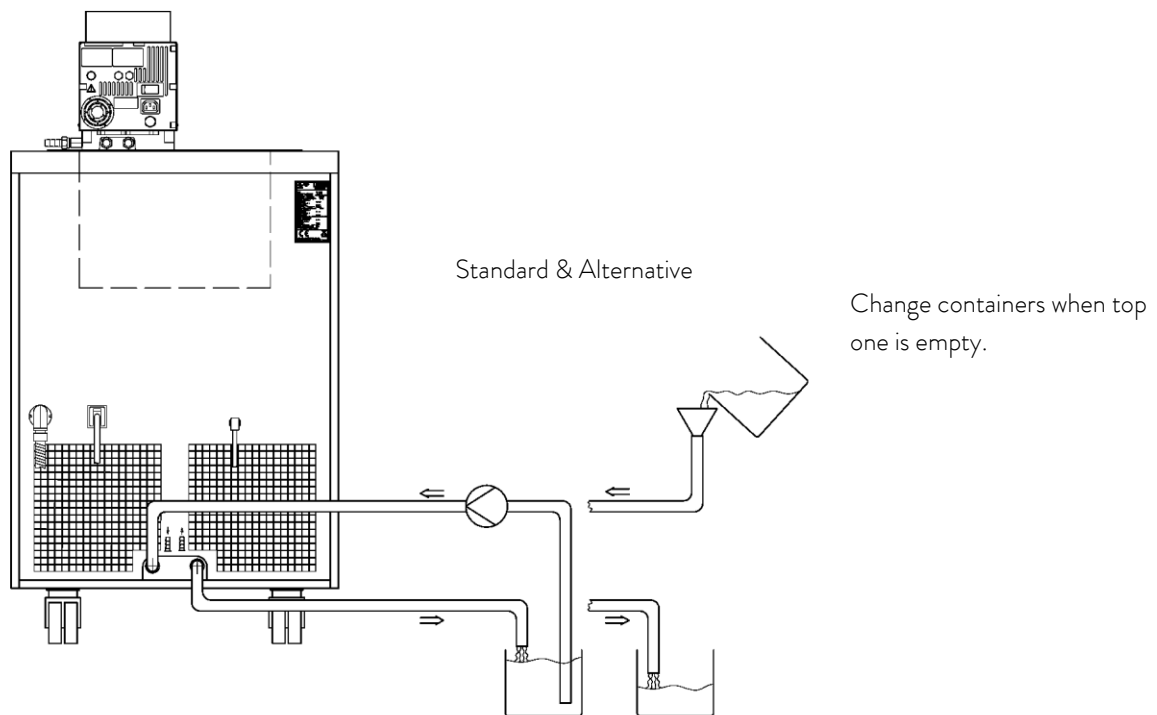

Acting time:	Continue the pump stage until most of the foamy reaction, usually at the start, has decayed. Generally, this is achieved after about 15 to 30 minutes.
Decalcifier:	Water with LAUDA Decalcifier LZB 126. It is essential to follow the safety instructions when handling the chemicals.
Flushing:	Allow at least 30 liters of water to flow through.

9.3.5 Repair information

If you need to send in a unit for repair, it is essential to first contact the LAUDA Service (⇒ 9.5).



- When sending in the unit, ensure that it is carefully and properly packed. LAUDA cannot be held liable for any damage caused by improper packing.

9.3.6 Remediating faults

Before you contact the LAUDA Service, check whether the problem can be remedied with the following instructions:

Fault	Possible remedy
Device does not cool or only very slowly.	<ol style="list-style-type: none"> 1. The module "Smart Cool" is set to "off" → Switch on "Smart Cool" module ⇒ 8.2. 2. Dirty condenser → Clean condenser ⇒ 9.3.4. 3. Temperature limit Til too high → Reduce temperature limit Til ⇒ 7.6.2.
Device does not heat up or only very slowly.	Temperature limit Tih too low → Increase temperature limit Tih ⇒ 7.6.2..
The compressors are running although there is no necessity of cooling.	Regular device function (protective function).
Master: Alarm message TEMP Command: Overtemperature protection. ⇒ 7.12.1.	Wait until the outflow temperature has cooled below the overtemperature cut-off point or set the cut-off point higher than the outflow temperature.
Master: Warning message LUArn 104 Command: Level very low (Imminent low level in the bath vessel). Master: Alarm message LEVEL Command: Low level. (Low level in the bath vessel) ⇒ 7.12.2.	<ol style="list-style-type: none"> 1. Check hoses, connections and load for whether a leaky location is present. → As applicable, rectify the leakage and top up the missing heat carrier liquid ⇒ 6.2 and 6.3. 2. Check the Proline Kryomat for whether a leaky location is present. → If necessary, contact LAUDA Service ⇒ 9.5. 3. The liquid may drop due to cooling or degassing. → If necessary, top up the missing heat transfer liquid ⇒ 6.2 and 6.3.
Master: Warning message LUArn 103 Command: Level too high (Imminent excessive level in the bath vessel). Master: Alarm message AL 6 Command: Level too high (Excessive level in the expansion vessel) ⇒ 7.12.4.	<ol style="list-style-type: none"> 1. Volume expansion of the heat transfer liquid during heating up. 2. Moisture absorption in the heat transfer liquid.

<p>Master: Alarm message BLDC</p> <p>Command: Pump blocked</p> <p>(Pump motor monitoring: Overload, blockage).</p> <p>⇒ 7.12.5.</p>	<ol style="list-style-type: none"> 1. The viscosity of the heat transfer liquid is too high → change heat transfer liquid or raise the setpoint temperature. 2. The pump is blocked. → Contact the LAUDA Service ⇒ 9.5.
<p>Master: Alarm message PULEU</p> <p>Command: Low level (pump)</p> <p>(Pump motor monitoring: No load).</p> <p>⇒ 7.12.6.</p>	<ol style="list-style-type: none"> 1. No liquid in the system. If this occurs, the level monitoring has failed. → Check whether the float in the expansion vessel is blocked by foreign bodies. Otherwise, contact LAUDA Service ⇒ 9.5. 2. With the option "open load" the device draws air out of the open load. → Move the return to the load.
<p>Master: Alarm message Error 11</p> <p>Command: Overpressure</p> <p>(outflow pressure too high).</p>	<p>Pump level too high → Select a lower pump level ⇒ 7.5.3.</p>
<p>Compressor overtemperature</p>	<p>⇒ 7.12.7</p>
<p>Three-phase current</p>	<p>⇒ 7.12.8</p>

9.4 Disposal information



The following applies for EU member states: The device must be disposed of according to Directive 2012/19/EU (WEEE Waste of Electrical and Electronic Equipment).

9.4.1 Disposal of the refrigerant



Uncontrolled escape of refrigerant / flying parts
<i>Crushing, impact, cuts</i>
<ul style="list-style-type: none"> • No disposal with pressurized refrigerant circuit). • The decommissioning is only permitted by a specialist.

The type and filling quantity of the refrigerant can be read on the unit or on the rating plate. Repair and disposal only through a qualified refrigeration engineer!

The following applies for EU member states: The disposal of the refrigerant must be carried out according to EC Directive 2015/2067/EU in conjunction with 517/2014/EU.

9.4.2 Disposal of the packaging

The following applies for EU member states: The disposal of the packaging must be carried out according to the EC Directive 94/62/EC.

9.5 Help desk and ordering replacement parts

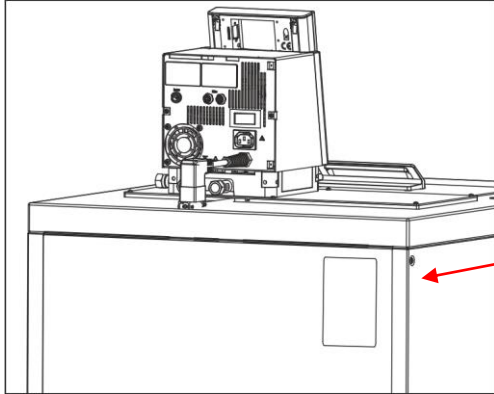

When ordering spares please quote instrument type and serial number from the nameplate. This avoids queries and supply of incorrect items.

Nameplate



Your contact for service and support:

LAUDA Service

Telephone: +49 (0)9343 503-350 (English and German)

Fax: +49 (0)9343 503-283

E-mail service@lauda.de

We are available any time for your queries and suggestions.

LAUDA DR. R. WOBSE GMBH & CO. KG

Laudaplatz 1

97922 Lauda-Königshofen

Germany

Telephone: +49 (0)9343 503-0

Fax: +49 (0)9343 503-222

E-Mail info@lauda.de

Internet <http://www.lauda.de>

10 Accessories

Description	Application	Catalogue number
LAUDA Wintherm Plus PC Program	Control of the thermostat, online display of all values as a graph with free choice of time frame. Incl. RS 232 cable (2m)	LDSM2002
RS 232/ 485 Interface modules	Digital Communication, operation of the LAUDA PC software Wintherm Plus ⇔ 8.3	LRZ 913
RS 232 Cable (2m)	Thermostat-PC Sub-D (9 pin. 9 pin)	EKS 037
RS 232 Cable (5m)	Thermostat-PC Sub-D (9 pin. 9 pin)	EKS 057
Analogue module	Current and voltage interface ⇔ 8.4	LRZ 912
Relays module with 3 input and 3 output channels	Import and export of thermostat signals ⇔ 8.5.1	LRZ 915
Relays module with 1 input and 1 output channel	NAMUR NE28 functionality ⇔ 8.5.2	LRZ 914
T-piece adapter cable for the LAUDA internal bus (LiBus) ⊕.	For the connection of further LiBus components (with heating thermostats two LiBus ⊕ connections are not occupied and one with cooling thermostats)	EKS 073
Extension for LiBus ⊕ 5m	For LiBus ⊕ components, but especially for remote operation with the Command remote control.	EKS 068
Extension for LiBus ⊕ 25m		EKS 069
Automatic refill device with LiBus ⊕ control.	Evaporating heat transfer liquid is automatically topped up.	LCZ 9661
Shut-off unit with LiBus ⊕ control.	Prevents the return of cooling liquid into the bath from external containers located above the bath.	LCZ 9673
Level controller without reverse-flow protection, mechanical function.	Keeps the liquid level in an open external bath at a constant level.	LCZ 0660
Raising platforms, application frames etc.	We will inform you about other accessories on request.	

Also, refer to our special and accessory brochures.

⊕ LiBus = LAUDA internal BUS (based on CAN).

11 Technical data and diagrams

The figures have been determined according to DIN 12876.

Table 1			RP 4050 C	RP 4050 CW	
Operating temperature- ACC range	°C	-50 – 200			
Ambient temperature range	°C	5 – 40			
Relative humidity		maximum relative humidity 80 % for temperatures up to 31 °C, decreasing linearly to 50 % relative humidity at 40 °C			
Device distance to the surroundings	cm	50	20		
Temperature range for storage	°C	-20 – 44 the condenser must be completely emptied by a water-cooled device (⇔ 9.2.2)			
Setting resolution	°C	0.1 / 0.01 (Master); 0.01 (Command)			
Display resolution	°C	Master: 0.01 Command: 0,1 / 0,01 / 0,001			
Display accuracy		±0.2 °C can be calibrated additively (→ Section 1.3 last Point)			
Temperature stability @ -10 °C with ethanol	K	±0.05			
Safety equipment	Class	III, FL suitable for flammable and non-flammable liquids			
Cooling		Air	Water		
Cooling water consumption: temperature 15 °C, pressure 3 bar ④	L/h			700	
Water-cooling connections (DIN EN 10226-1)	inch			G ¾"	
Heater power 400 V	kW	maximum 3.5			
Heater power 208 V	kW	maximum 3.0			
Heater power 200 V	kW	maximum 2.8			
Cooling power at 20 °C t _{amb} @ bath temp. (Pump Level 6)	with heat transfer oil	200 °C	kW	5.0	6.0
	with ethanol	20 °C	kW	5.0	6.0
		0 °C	kW	3.0	3.5
		-20 °C	kW	1.6	1.8
		-30 °C	kW	1.0	1.1
		-40 °C	kW	0.5	0.6
		-50 °C	kW	0.25	0.25
Pump type		Pressure pump, 4 power levels (level 5 to 8)			
Discharge pressure max.	bar	0.5 at pump power level 8			

Table 1		RP 4050 C	RP 4050 CW
Flow rate max. (pressure)	L/min	19 at pump power level 8	
Hose connections		Thread M16 x 1; olives 13 mm external diameter	
Bath volume from – to	L	32 – 44	
Bath opening B x L	mm	350 x 350	
Bath depth / usable depth	mm	250 / 230	
Height to top of bath	mm	905	
Overall dims. B x L	mm	600 x 700	
Overall dim. H	mm	1160	
Weight	kg	130	
Power consumption 400 V	kW	5.0	
Power consumption 208 V	kW	5.0	
Power consumption 200 V	kW	5.0	
Ingress protection rating → IP Code accord. to IEC 60529		IP 2 1	
Protection class		Protection class 1 according to DIN EN 61140 VDE 0140-1	

Table 2			RP 3090 C	RP 3090 CW	RP 4090 C	RP 4090 CW	
Operating temperature - ACC range		°C	-90 – 200				
Ambient temperature range		°C	5 – 40				
Relative humidity			maximum relative humidity 80 % for temperatures up to 31 °C, decreasing linearly to 50 % relative humidity at 40 °C				
Device distance to the surroundings		cm	50	20	50	20	
Temperature range for storage		°C	-20 – 44 the condenser must be completely emptied by a water-cooled device (⇒ 9.2.2)				
Setting resolution		°C	0.1 / 0.01 (Master); 0.01 (Command)				
Display resolution		°C	Master: 0.01 Command: 0,1 / 0,01 / 0,001				
Display accuracy			±0.2 °C can be calibrated additively (→ Section 1.3 last Point)				
Temperature stability @ -10 °C with ethanol		K	±0.05				
Safety equipment		Class	III, FL suitable for flammable and non-flammable liquids				
Cooling			Air	Water	Air	Water	
Cooling water consumption: temperature 15 °C, pressure 3 bar ④		L/h		700		700	
Water-cooling connections (DIN EN 10226-1)		inch		G ¾"		G ¾"	
Heater power 400 V		kW	maximum 3.5				
Heater power 208 V		kW	maximum 3.0				
Heater power 200 V		kW	maximum 2.8				
Cooling power at 20 °C t_{amb} @ bath temp. (Pump Level 6)	with heat transfer oil	200 °C	kW	3.0	4.0	3.0	4.0
	with ethanol	20 °C	kW	3.0	4.0	3.0	4.0
		0 °C	kW	2.9	3.7	2.9	3.7
		-20 °C	kW	2.5	3.1	2.5	3.1
		-30 °C	kW	2.3	2.7	2.3	2.7
		-40 °C	kW	2.0	2.0	2.0	2.0
		-50 °C	kW	1.6	1.6	1.6	1.6
		-60 °C	kW	1.3	1.3	1.3	1.3
		-70 °C	kW	0.8	0.8	0.8	0.8
		-80 °C	kW	0.5	0.5	0.5	0.5
		-90 °C	kW	0.15	0.15	0.15	0.15

Table 2		RP 3090 C	RP 3090 CW	RP 4090 C	RP 4090 CW
Pump type		Pressure pump, 4 power levels (level 5 to 8)			
Discharge pressure max.	bar	0.5 at pump power level 8			
Flow rate max. (pressure)	L/min	19 at pump power level 8			
Hose connections		Thread M16 x 1; olives 13 mm external diameter			
Bath volume from – to	L	23 – 31		32 – 44	
Bath opening B x L	mm	350 x 200		350 x 350	
Bath depth / usable depth	mm	250 / 230			
Height to top of bath	mm	905			
Overall dims. B x L	mm	600 x 700			
Overall dim. H	mm	1160			
Weight	kg	155			
Power consumption 400 V	kW	7.0			
Power consumption 208 V	kW	7.0			
Power consumption 200 V	kW	7.0			
Ingress protection rating → IP Code accord. to IEC 60529		IP 2 1			
Protection class		Protection class 1 according to DIN EN 61140 VDE 0140-1			

		Proline Kryomat with external pump																																			
Catalogue number	---	L001669 L001670 L001671 L001673	L001674 L001675 L001693 L001694	L001695 L001698 L001699 L002583																																	
Operating temperature - ACC range	°C	-40 - 150																																			
<table border="1"> <caption>Approximate data points from the graph</caption> <thead> <tr> <th>Flow rate (L/min)</th> <th>Pressure (bar) at 50 Hz</th> <th>Pressure (bar) at 60 Hz</th> </tr> </thead> <tbody> <tr><td>2</td><td>3.1</td><td>4.3</td></tr> <tr><td>5</td><td>2.8</td><td>3.9</td></tr> <tr><td>10</td><td>2.4</td><td>3.4</td></tr> <tr><td>15</td><td>2.0</td><td>3.0</td></tr> <tr><td>20</td><td>1.6</td><td>2.6</td></tr> <tr><td>25</td><td>1.2</td><td>2.2</td></tr> <tr><td>30</td><td>0.8</td><td>1.8</td></tr> <tr><td>35</td><td>0.3</td><td>1.4</td></tr> <tr><td>40</td><td>-</td><td>1.0</td></tr> <tr><td>45</td><td>-</td><td>0.2</td></tr> </tbody> </table>					Flow rate (L/min)	Pressure (bar) at 50 Hz	Pressure (bar) at 60 Hz	2	3.1	4.3	5	2.8	3.9	10	2.4	3.4	15	2.0	3.0	20	1.6	2.6	25	1.2	2.2	30	0.8	1.8	35	0.3	1.4	40	-	1.0	45	-	0.2
Flow rate (L/min)	Pressure (bar) at 50 Hz	Pressure (bar) at 60 Hz																																			
2	3.1	4.3																																			
5	2.8	3.9																																			
10	2.4	3.4																																			
15	2.0	3.0																																			
20	1.6	2.6																																			
25	1.2	2.2																																			
30	0.8	1.8																																			
35	0.3	1.4																																			
40	-	1.0																																			
45	-	0.2																																			

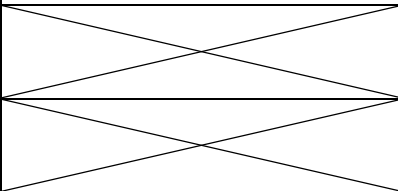
ACC range is the working temperature range during operation with an active cooling unit.

		Proline Kryomat with external pump		
Catalogue number	---	L001661 L001662 L001663 L001665 L001666	L001667 L001685 L001686 L001687	L001690 L001691 L003524 L003525
Operating temperature - ACC range	°C	-90 - 150		

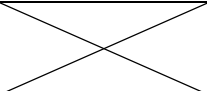
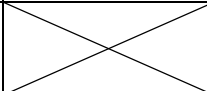
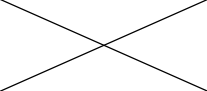
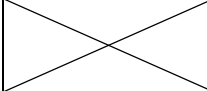
Flow rate (L/min)	Pressure (bar) - 50 Hz	Pressure (bar) - 60 Hz
0	0.95	1.30
10	0.93	1.28
20	0.91	1.25
30	0.86	1.18
40	0.80	1.10
50	0.73	1.02
60	0.65	0.93
70	0.55	0.83
80	0.43	0.72
90	0.28	-

ACC range is the working temperature range during operation with an active cooling unit.

11.1 Installation location

- Ensure that adequate ventilation is provided
- Minimum free room volume, room volume per kg of refrigerant according to DIN 378-1 (For refrigerant quantity, see type plate or Chapter (⇒ 11.3 Refrigerant and filling quantity)).

Table: Refrigerant and room volume

Refrigerant	Room volume per kg of refrigerant
R-449A	2.81 m ³ /kg
R-452A	2.37 m ³ /kg
R-508B	4.0 m ³ /kg

11.2 Mains connection data

Proline Kryomat air-cooled

Mains connection data	RP 4050 C	RP 3090 C	RP 4090 C
400 V +8/-10 %; 3/N/PE~50 Hz	X	X	X
208 V ±8 %; 3/PE~60 Hz	X	X	X
200 V ±10 %; 3/PE~50/60 Hz	X	X	X

Proline Kryomat water-cooled

Mains connection data	RP 4050 CW	RP 3090 CW	RP 4090 CW
400 V +8/-10 %; 3/N/PE~50 Hz	X	X	X
208 V ±8 %; 3/PE~60 Hz	X	X	X
200 V ±10 %; 3/PE~50/60 Hz	X	X	X

Technical modifications reserved.

11.3 Refrigerant and filling quantity

The device contains fluorinated greenhouse gases.

	Unit	RP 4050 C	RP 4050 CW
Refrigerant	---	R-449A	R-449A
maximum filling quantity	kg	1.6	1.6
GWP _(100a) *	---	1397	1397
CO ₂ equivalent	t	2.2	2.2

Devices with two compressors

	Unit	RP 3090 C	RP 3090 CW	RP 4090 C	RP 4090 CW
Refrigerant 1	---	R-452A	R-452A	R-452A	R-452A
maximum filling quantity	kg	1.6	1.6	1.6	1.6
GWP _(100a) *	---	2140	2140	2140	2140
CO ₂ equivalent	t	3.4	3.4	3.4	3.4
Refrigerant 2	---	R-508B	R-508B	R-508B	R-508B
maximum filling quantity	kg	0.73	0.73	0.73	0.73
GWP _(100a) *	---	13400	13400	13400	13400
CO ₂ equivalent	t	9.8	9.8	9.8	9.8



Global Warming Potential (GWP),
Comparison CO₂ = 1,0

*Time span 100 years – according to IPCC IV

Pump characteristics
 measured with water
 internal pump PL 4

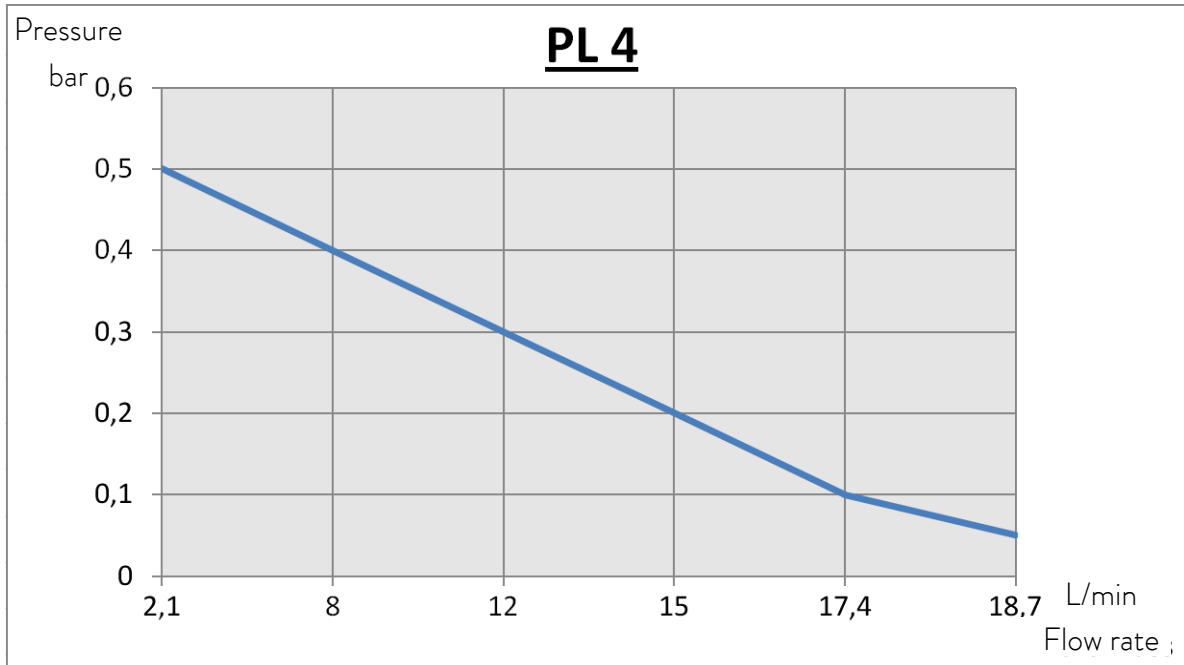

Cooling curves

Cooling curves 1-stage

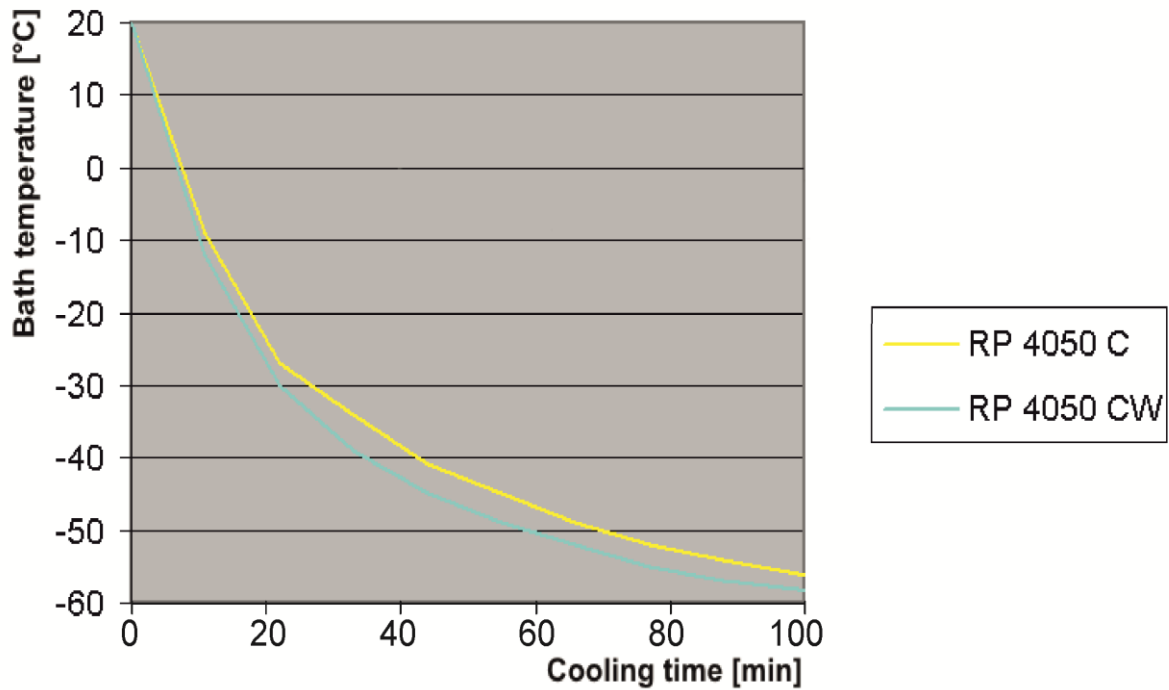

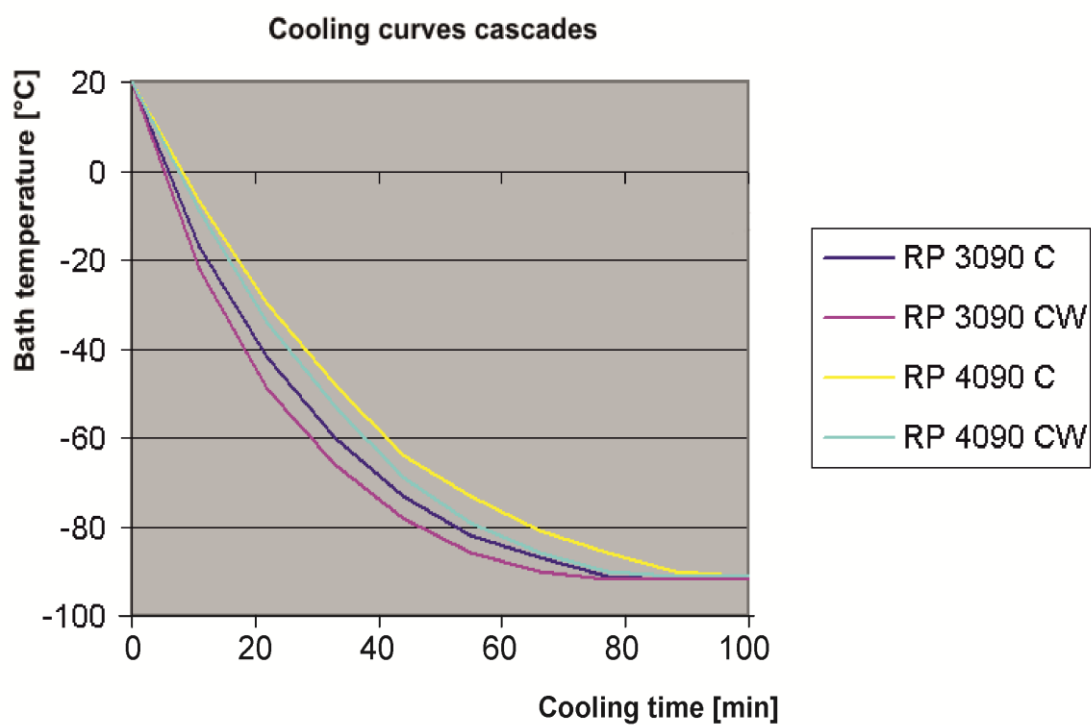

Cooling curves; Bath closed; Heat transfer liquid: Ethanol; Time in minutes; Temperature in °C.

Influence of ambient temperature at air-cooled Kryomats

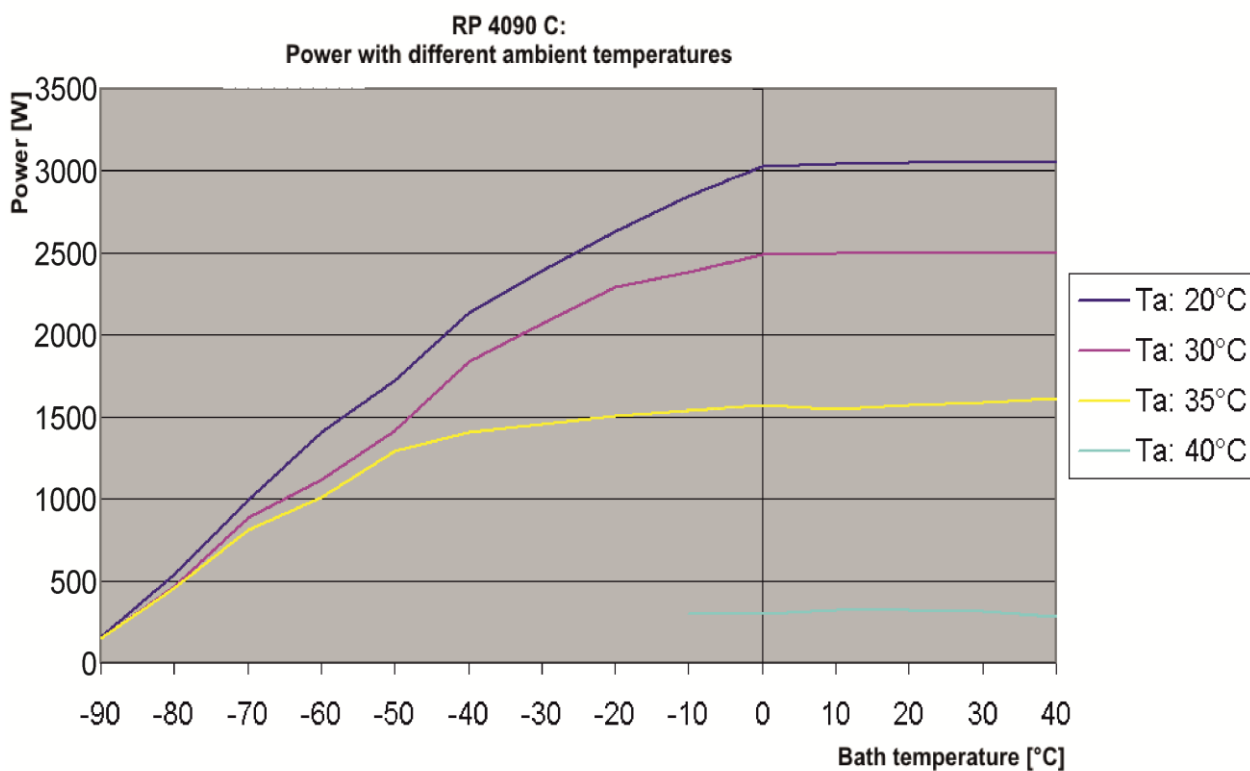

12 Declaration of conformity and product returns declaration



EC DECLARATION OF CONFORMITY

Manufacturer: LAUDA DR. R. WOBSEK GMBH & CO. KG
Laudaplatz 1, 97922 Lauda-Königshofen Germany

We hereby declare under our sole responsibility that the machines described below

Product Line: Proline Kryomat **Serial number:** from S190000001

Types: RP 3050 C, RP 3050 CW, RP 4050 C, RP 4050 CW,
RP 3090 C, RP 3090 CW, RP 4090 C, RP 4090 CW

comply with all relevant provisions of the EC Directives listed below due to their design and type of construction in the version brought on the market by us:

Machinery Directive	2006/42/EC
EMC Directive	2014/30/EU
RoHS Directive	2011/65/EU In connection with (EU) 2015/863

The equipment is not covered by the Pressure Equipment Directive 2014/68/EU, as the maximum classification of the equipment is Category 1 and it is covered by the Machinery Directive.

The protective objectives of the Machinery Directive with regard to electrical safety are complied with in accordance with Annex I Paragraph 1.5.1 in conformity with the Low Voltage Directive 2014/35/EU.

Applied harmonized standards:

- EN 12100:2011 (ISO 12100:2010)
- EN 61326-1:2013 (IEC 61326-1:2012)
- EN 378-2:2018
- EN 61010-1:2011 (IEC 61010-1:2010 + Cor. :2011)
- EN 61010-2-010:2015 (IEC 61010-2-010:2014)

Authorized representative for the composition of the technical documentation:

Dr. Jürgen Dirscherl, Director Research & Development

Lauda-Königshofen, 24.09.2021

Dr. Alexander Dinger, Head of Quality Management

Document number: Q5WA-QA13-014-EN Version 03

*FAHRENHEIT. *CELSIUS. *LAUDA.

Product Returns and Clearance Declaration

Product Returns

Would you like to return a LAUDA product you have purchased to LAUDA? For the return of goods, e.g. for repair or due to a complaint, you will need the approval of LAUDA in the form of a *Return Material Authorization (RMA)* or *processing number*. You can obtain the RMA number from our customer service department at +49 (0) 9343 503 350 or by email service@lauda.de.

Return address

LAUDA DR. R. WOBSEY GMBH & CO. KG

Laudaplatz 1

97922 Lauda-Königshofen

Deutschland/Germany

Clearly label your shipment with the RMA number. Please also enclose this fully completed declaration.

RMA number	Product serial number
Customer/operator	Contact name
Contact email	Contact telephone
Zip code	Place
Street & house number	
Additional explanations	

Clearance Declaration

The customer/operator hereby confirms that the product returned under the above-mentioned RMA number has been carefully emptied and cleaned, that any connections have been sealed to the farthest possible extent, and that there are no explosive, flammable, environmentally hazardous, biohazardous, toxic, radioactive or other hazardous substances in or on the product.

Place, date	Name in block letters	Signature

Version 02 - EN

13 Index

A

Accessories.....	121
Acoustic signals.....	63
Activate standby.....	52
Activating external control.....	54
Alarms.....	89
alternating mode.....	109
Analog module.....	21
Analogue module.....	108
Auto start.....	59

B

Basic	
window.....	45
Bath temperature display.....	41
BLDC Pump blocked.....	94
Brightness.....	44
Bypass valve.....	19

C

Calibration, temperature probe.....	63
Changing window.....	46
Cleaning the condenser.....	116
Cleaning the surface.....	112
Clock	57, 80
Compressor.....	22
Con control.....	54
Condenser.....	22
Connection, pump.....	20
Contact module.....	22, 109
Contrast.....	44
Control parameter set.....	85
Control parameters.....	82
Control Variable	55
Cooling capacity.....	30
Cooling water quality.....	34
Cooling water specification.....	32, 34
Correction limitation.....	83
Create a program.....	72
Current consumption.....	56
Current Consumption	56
Cursor keys.....	43

D

Decalcifying.....	117
Decimal-point key.....	44
Delete.....	73

Device data	111
Device status.....	111
Dewing.....	22
Dirt trap.....	116
Display data	46
Display resolution.....	58
Disposal.....	32
Disposal information.....	119
Draining.....	30
Duo key, Command.....	44

E

<i>ER</i> analog module	
control source.....	55
Edit	73
EMC standard DIN EN 61326-1.....	9
Enter key	
Command.....	43
Master.....	42
<i>EP</i> external probe	
control source.....	55
Error list.....	89
error store	112
Errors.....	89
<i>ES</i> serial module	
control source.....	55
Escape key.....	43
EXT external temperature probe.....	52
External temperature.....	51

F

Fault list "Alarms and Warnings".....	96
Filling.....	30
Filling quantity.....	128
Flammable liquids.....	31
Format of date	57
Free space.....	30

G

Graph.....	66, 77
Graph recorder.....	66
Graphical display.....	66
Graphical measurement display.....	46

H

Hazard sources.....	9
Hazards.....	9
Heat transfer liquid	

Selection.....	33
Setpoint.....	49
testing.....	115
Viscosity.....	20
Heat transfer oils.....	31
Heater rating.....	22
High-level settings.....	92
High-level warning/ alarm.....	93
Hoses.....	35

I

Info.....	78
Instructed specialist personnel.....	9
Interface modules.....	21
Internal probe control source.....	55
Interrogating device type.....	111

K

Key for arithmetic sign.....	44
Key functions.....	42

L

LABVIEW.....	107
Language	41
LED signals.....	43
LEUEL Low-level alarm.....	91
Liquid level.....	31
Liquids, flammable.....	31
Load	
At higher position.....	37
External.....	51
Locking the keyboard.....	47
Locking, keyboard.....	47
Loops.....	77
Low-level alarm.....	91

M

Main fuse switch.....	40
Mains connection.....	40
Maintenance.....	111
Modules.....	21
install.....	99

N

Nameplate.....	40, 120
----------------	---------

O	
Offset source	61
Offset, temperature probe	63
Out 1 (Program)	76
Nozzles	19
Overtemperature cut-off	90
Overtemperature protection	89

P	
Pause program	71
Power level, pump	20
Profibus Modules	22
Program sequence	77
Programmer	68, 70
P_{U} pump power levels	52
Pump	19
Connector	19
Low level	94
Program setting	75
Unused connectors	37
Pump Level	53
Pump-motor supervision	
Dry running	94
Overload	94

R	
Ramp	68
Ramp function	79
Refrigerant	119, 128
Refrigerating machine	22
Refrigerating unit	22
Remedying faults	118
Repair information	117
RS 232/485 Interface module	21

S	
SAFE keyboard locking	47

Safety functions	89
Safety information	8
Safety notes	3
Safety system	20
Screen displays	44
Screen Graph recorder	66
Sealing caps	30
Segment	68
Segment "Start"	69
Segment time	74
Select program	70
Self Adaption	86
SelfCheck Assistant	20, 89
Self-test	41
Serial interface RS 232/485	101
Serial numbers	111
Service contact	120
Service intervals	115
Servicing	113
Set date	57
SEt setpoint setting	49
Set time	57
Setpoint offset	61
Setting of numerical values	42
Setting pump power	52
SmartCool technology	22
Socket 10S	51
Soft keys	44
Software version	111
Sounds	63
Spare parts	120
Standard window	45
Standby	42
Standby activation	44
Starting up	38
Status	70, 71
Super window	46
Switching off	42

T	
T end °C	73
Technical data	122
TEMP Overtemperature alarm	90
Temperature	58
display resolution	58
External probe	51
Gradient	51
Limits	60
Setpoint setting	49
Temperature Limits	60
T_{ext} external temperature	52
T_{fix} Default setpoint temp.	50
Time	74
Timer	80
Timer function	80
Tolerance (Program)	75
Tolerance range	69
T_{set} Setpoint temperature setting	50
Tv manual/auto	83
Type designation	19
Type of start mode	59

U	
Unlocking	48

V	
Varioflex pump	19
Version of the software	111

W	
Warnings	89
Weekplan	80
Works settings	62
WARN Warning	93
WARN 103 High-level warning	93

Manufacturer

LAUDA DR. R. WOBSE GMBH & CO. KG ° Laudaplatz 1 ° 97922 Lauda-Königshofen

Telephone: +49 (0)9343 503-0 ° Fax: +49 (0)9343 503-222

E-mail: info@lauda.de ° Internet: <https://www.lauda.de>